

## OPERATING INSTRUCTIONS



**AR680**



**AR640**



**AR660**



**AR690**



**AR600**



**AR650**

**AR630**



## PROGRAMMABLE MICROPROCESSOR CONTROLLERS



Thank you for choosing our product. These instructions will facilitate operating the device and enable safe use of the controller at its full capacity. Prior to the installation and startup of the device, please become familiar with these instructions. In the event of any additional questions, please contact our technical adviser.

## CONTENTS

1. SAFETY PRINCIPLES.....	3
2. INSTALLATION GUIDELINES.....	3
3. GENERAL CHARACTERISTICS OF THE CONTROLLERS.....	3
4. CONTENTS OF THE SET.....	4
5. TECHNICAL DATA.....	4
6. ENCLOSURE DIMENSIONS AND INSTALLATION DATA.....	6
7. DESCRIPTION OF TERMINAL STRIPS AND ELECTRICAL CONNECTIONS.....	7
<b>8. IMPORTANT COMMENTS PERTAINING TO OPERATION .....</b>	<b>8</b>
9. FUNCTIONS OF BUTTONS AND LED DIODES. MINIMUM AND MAXIMUM VIEW. ....	9
10. BINARY INPUT.....	9
11. SETTING OF THE CONFIGURATION PARAMETERS.....	10
12. QUICK ACCESS MENU.....	14
13. OUTPUT OPERATION CONFIGURATION .....	14
13.1. CHANGING THE PRESET OUTPUT VALUES.....	14
13.2. TYPES OF OUTPUT CHARACTERISTICS.....	15
13.3. ANALOG OUTPUT.....	16
13.4. PID REGULATION.....	16
13.5. AUTOMATIC PID PARAMETER SELECTION .....	17
13.6. PID PARAMETER CORRECTION .....	18
13.7. MANUAL AND REMOTE CONTROL FUNCTION .....	18
14. MESSAGE AND ERROR SIGNALING .....	18
15. CONNECTING THE CONTROLLER TO A COMPUTER AND AVAILABLE SOFTWARE.....	19
16. RS485 COMMUNICATION INTERFACE (acc. to EIA RS-485) .....	20
17. MODBUS–RTU SERIAL TRANSMISSION PROTOCOL (SLAVE) .....	20
18. USER'S NOTES .....	23



Please pay particular attention to the text marked with this sign.

The manufacturer reserves the right to make changes to the design and the programming of the device without any deterioration of the technical parameters.

## 1. SAFETY PRINCIPLES



- before you start to use the device, become familiar with the present instructions;
- in order to avoid electrocution or damage to the device, its mechanical and electrical installation must be performed by qualified staff;
- before switching on the power supply, make sure that all cables and wires are properly connected;
- before making any modifications to the wire and cable connections, switch off the device's power supply;
- ensure proper operating conditions compliant with the technical specification of the device (power supply voltage, humidity, temperature - see chapter 5).

## 2. INSTALLATION GUIDELINES



The device is designed so as to ensure an appropriate level of immunity to most interferences that may occur in industrial environments. In environments of unknown level of interferences, it is recommended to implement the following measures so as to prevent potential interference with the operation of the device:

- do not supply the device from the same lines as high-power equipment without using appropriate power line filters;
- use cable shields on power supply cables, sensor cables, and signal cables, whereby the earthing of the shield should be single-point and located as close to the device as possible;
- avoid running instrument (signal) cables in the direct vicinity of and parallel to power distribution and power supply cables;
- it is recommended to use twisted pair signal cables;
- in the case of sensing resistors in 3-wire connections, use identical wires;
- avoid locating remotely controlled, electromagnetic meters, and high-power loads, loads with phase or group power control, and other devices producing large impulse interferences close to one another;
- ground or zero metal rails on which rail-mounted devices are installed.

Make sure to remove the protective film from the LED display before the first use of the device.

## 3. GENERAL CHARACTERISTICS OF THE CONTROLLERS

- regulation and monitoring of temperature and other physical values (humidity, pressure, level, speed, etc.) processed to a standard electrical signal (0/4÷20mA, 0÷10V, 0÷60mV, 0÷2,5kΩ);
- 1 universal measurement input (thermoresistance, thermocouple, and analog) with memory of the minimum and maximum measured value and a remote data display function (over the MODBUS-RTU protocol);
- programmable digital input to change the controller's mode of operation: control start/stop, manual mode for outputs, step-wise change of the preset value (day/night), keypad block, display indications stop (HOLD function);
- 2 or 3 ON-Off outputs of the following control characteristics:
  - output 1 (main): ON-OFF with hysteresis, PID, AUTOTUNING PID
  - output 2, 3 (auxiliary/alarm): ON-OFF with hysteresis
- analog output 0/4÷20mA or 0/2÷10V (continuous-control, retransmission)
- possibility to convert the input signals into the analog output standard in the measurement retransmission mode;
- advanced PID parameter selection function with fuzzy logic elements;
- manual mode (open control loop) available for bi-state and analog outputs which enables setting the output signal value in the range of 0-100%;
- digital LED readout with programmable color (only AR630, AR650, and AR680) and illumination brightness;
- signaling of alarm states (connected outputs) with a variable display color (AR630, AR650, and AR680);
- integrated 24 V DC power supply supplying the field transducers;
- RS485 serial interface (galvanically isolated, MODBUS-RTU protocol);

- programmable type of input, range of indications (for analog inputs), control, alarms, display, communication, and access options, and other configuration parameters;
- compensation of line resistance for resistance sensors and of temperature of cold thermocouple tips;
- access to configuration parameters protected with a user password;
- parameter configuration methods:
  - from the film keypad located on the front panel of the device;
  - through the RS485 or the AR955 programmer and the ARSOFT-WZ1 free software (Windows 2000/XP/Vista/7/8);
- software and the AR955 programmer that enables viewing the measured value and quick configuration; single or ready sets of parameters pre-saved on the computer in order to be used again, for example in other controllers of the same type (duplication of configuration);
- panel enclosure (IP65 from the front, IP54 - AR690), AR660 - enclosure for mounting on a DIN rail, 35 mm (IP20), AR630 - industrial enclosure, IP65;
- optionally (to be selected at the time of order): 24 V AC/DC power supply, SSR control output, 0/2÷10V analog output, and RS485 interface;
- high accuracy, long-term stability, and immunity to interferences;
- available accessories:
  - AR955 programmer (with optional adapter for AR600 - version AR955/GP)
  - RS485/USB converter.

**NOTE:** 

**Before starting to work with the controller, you must become familiar with this operating instructions, properly prepare the electrical system and the mechanical system, and correctly configure the parameters.**

## 4. CONTENTS OF THE SET

- a controller with grips for installation in a panel window;
- operating instructions;
- a warranty card.

## 5. TECHNICAL DATA

1 universal input (set with parameter 0: $R_{in}$ )	measurement range
- Pt100 (RTD, 3- or 2-wire)	-200 ÷ 850 °C
- Ni100 (RTD, 3- or 2-wire)	-50 ÷ 170 °C
- Pt500 (RTD, 3- or 2-wire)	-200 ÷ 620 °C
- Pt1000 (RTD, 3- or 2-wire)	-200 ÷ 520 °C
- thermocouple J (Fe-CuNi)	-40 ÷ 800 °C
- thermocouple K (NiCr-NiAl)	-40 ÷ 1,200 °C
- thermocouple S (PtRh 10-Pt)	-40 ÷ 1,600 °C
- thermocouple B (PtRh30PtRh6)	300 ÷ 1800 °C
- thermocouple R (PtRh 13-Pt)	-40 ÷ 1,600 °C
- thermocouple T (Cu-CuNi)	-25 ÷ 350 °C
- thermocouple E (NiCr-CuNi)	-25 ÷ 820 °C
- thermocouple N (NiCrSi-NiSi)	-35 ÷ 1,300 °C
- current ( $R_{in} = 50 \Omega$ )	0/4 ÷ 20 mA
- voltage ( $R_{in} = 110 \text{ k}\Omega$ )	0 ÷ 10 V
- voltage ( $R_{in} > 2 \text{ M}\Omega$ )	0 ÷ 60 mV

- resistance (3- or 2-wire)	0 ÷ 2,500 Ω
- remote data display (through the RS485 or PRG port)	-1999 ÷ 9999
<b>Response time</b> (10 ÷ 90%)	0.25 ÷ 3 s (programmable with parameter 1: <b>F</b> <b>(4.4)</b> )
<b>Resistance of leads</b> (RTD, Ω)	R <sub>0</sub> < 25 Ω (for each line)
<b>Resistance input current</b> (RTD, Ω)	400 μA (Pt100, Ni100), 200 μA (others)
<b>Processing errors</b> (at ambient temperature of 25 °C):	
- basic	- for RTD, mA, V, mV, Ω - for thermocouples
	0.1% of the measurement range ±1 digit
	0.2% of the measurement range ±1 digit
- additional for thermocouples	<2 °C (temperature of cold tips)
- additional from ambient temperature changes	< 0.003% of the input range /°C
<b>Resolution of measured temperature</b>	programmable, 0.1 °C or 1 °C
<b>Range of indications</b> (resolution of analog inputs)	-1999 ÷ 9999, programmable
<b>Position of the decimal point for analog inputs</b>	programmable, 0 ÷ 0.000
<b>Binary input</b> (contact or voltage <24 V)	bistable, active level: short circuit or <0.8 V
<b>Communication interfaces</b> (RS485 and PRG, do not use simultaneously)	- RS485 (galvanically separated), option - PRG programming connection (no separation), standard
	- speed 2.4 ÷ 115.2 kb/s, - character format 8N1 (8 data bits, 1 stop bit, no parity bits) - MODBUS-RTU protocol (SLAVE)
<b>Bi-state outputs</b> (3 or 2 for AR600, relay or SSR)	- relay (P1, P2, P3), standard (P3 unavailable for AR600) - SSR (SSR1, SSR2, SSR3), option (SSR3 unavailable for AR600)
	8A / 250 V AC 1 main (SPDT), 2 additional (SPST-NO), <b>AR600, AR660</b> : 5A / 250VAC (SPST-NO), <b>AR630</b> : 1 main (SPDT) - 8A / 250 VAC, 2 additional (SPST-NO) - 5A / 250 VAC, for resistance loads
	transistor type NPN OC, 10.5 ÷ 11 V, internal resistance 440 Ω, AR630, AR690 - current sources approx. 22 mA / 10 V
<b>Analog output</b> (1 current or voltage, not separated from the measuring input)	- current 0/4 ÷ 20 mA (standard) - voltage 0/2 ÷ 10 V (option) - basic error of the output
	maximum resolution 1.4 μA (14 bit) output load, R <sub>o</sub> < 350 Ω
	maximum resolution 0.7 mV (14 bit) output load, I <sub>o</sub> < 3.7 mA (R <sub>o</sub> > 2.7 kΩ)
	< 0.1% of the output range
<b>7-segment LED display</b> 4 digits with programmable color (only AR630, AR650, and AR680) and brightness	<b>AR650/680/630</b> - 20 mm, 5 colors (red, dark- and bright-orange, yellow, green), <b>AR640/600</b> - 9 mm, <b>AR660</b> -10 mm, <b>AR690</b> - 25 mm, red
<b>LED signalization of:</b>	- relay activity - messages and errors
	LED diodes, variable display color in AR650/680/630 display
<b>Power supply</b> (Usup)	- 230 VAC (standard) - 24 VAC/DC (option)
	85 ÷ 260 VAC/ 3VA 20 ÷ 50 VAC/ 3 VA, 22 ÷ 72 VDC/ 3W
<b>Power supply of field transducers</b>	24 VDC / 30 mA
<b>Operating environment, rated operating conditions</b>	air and neutral gases, 0÷50 °C, <100% RH (no condensation)
<b>Protection rating</b>	AR630 - IP65, AR660 - IP20, others IP65 from the front (AR690 - IP54), IP20 from the side of the connections
<b>Weight</b>	approx. 200 g (AR650, AR640), approx. 275 g (AR680), approx. 135 g (AR600), approx. 160 g (AR660), approx. 305 g (AR690)), approx. 325 g (AR630)
<b>Electromagnetic compatibility (EMC)</b>	immunity: according to the PN-EN 61000-6-2:2002(U) standard emissivity: according to the PN-EN 61000-6-4:2002(U) standard

## 6. ENCLOSURE DIMENSIONS AND INSTALLATION DATA

### a) AR650, AR640, AR600

<b>Enclosure type</b>	panel, Incabox XT L57
<b>Material</b>	self-extinguishing NORYL 94V-0, polycarbonate
<b>Enclosure dimensions</b> (W x H x D)	<b>AR650:</b> 96x48x79 mm, <b>AR640:</b> 48x96x79 mm <b>AR600:</b> 48x48x79 mm
<b>Panel window</b> (W x H)	<b>AR650:</b> 92 x 46 mm, <b>AR640:</b> 46 x 92 mm <b>AR600:</b> 46 x 46 mm
<b>Fixing methods</b>	grips on the side of the enclosure
<b>Conductor cross-sections</b> (separable connectors)	2.5 mm <sup>2</sup> (supply and bi-state outputs), 1.5 mm <sup>2</sup> (others)

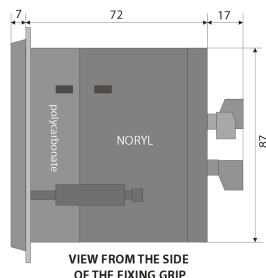
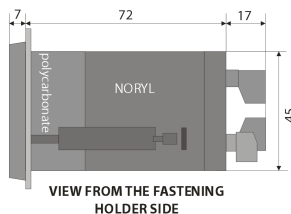

### b) AR680

<b>Enclosure type</b>	panel, Incabox XT L57
<b>Material</b>	self-extinguishing NORYL 94V-0, polycarbonate
<b>Enclosure dimensions</b>	96 x 96 x 79 mm (W x H x D)
<b>Panel window</b>	92 x 89 mm (W x H)
<b>Fixing methods</b>	grips on the side of the enclosure
<b>Conductor cross-sections</b> (separable connectors)	2.5 mm <sup>2</sup> (supply and bi-state outputs), 1.5 mm <sup>2</sup> (others)

### c) AR660

<b>Enclosure type</b>	rail-mounted, Modulbox 3MH53
<b>Material</b>	ABS/PC
<b>Enclosure dimensions</b>	53 x 90 x 62 mm (W x H x D)
<b>Fixing methods</b>	on a TS35 rail (DIN EN 50022-35)
<b>Conductor cross-sections</b> (separable connectors)	2.5 mm <sup>2</sup> (supply and bi-state outputs), 1.5 mm <sup>2</sup> (others)

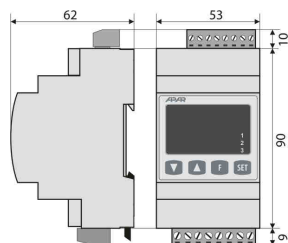

### d) AR690

<b>Enclosure type</b>	panel, Incabox L57
<b>Material</b>	self-extinguishing NORYL 94V-0
<b>Enclosure dimensions</b>	144 x 72 x 72 mm (W x H x D)
<b>Panel window</b>	138 x 67 mm (W x H)
<b>Protective cover IP54</b>	AR967 (option)
<b>Fixing methods</b>	grips on the side of the enclosure
<b>Conductor cross-sections</b> (separable connectors)	2.5 mm <sup>2</sup> (supply and bi-state outputs), 1.5 mm <sup>2</sup> (others)

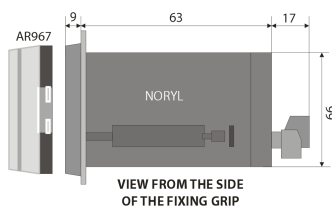

### e) AR630

<b>Enclosure type</b>	industrial IP65, Gainta G2104
<b>Material</b>	polycarbonate
<b>Enclosure dimensions</b>	120 x 80 x 55 mm (W x H x D)
<b>Fixing methods</b>	4 holes, dia. 4.3 mm, distance 108x50 mm, accessible after the front cover is removed
<b>Conductor cross-sections</b> (separable connectors)	2.5 mm <sup>2</sup> (supply and bi-state outputs), 1.5 mm <sup>2</sup> (others)

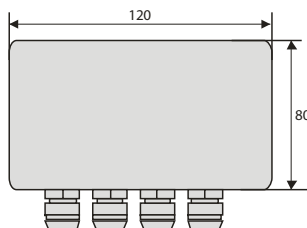

## 7. DESCRIPTION OF TERMINAL STRIPS AND ELECTRICAL CONNECTIONS

Table 7. Numbering and description of terminal strips

Clamps	Description
1-2-3	Input (2- and 3-wire) Pt100, Ni100, Pt500, Pt1000, resistance,
2-3	thermocouple input TC (J, K, S, B, R, T, E, N) and voltage input 0÷60 mV
3-5	current input 0/4÷20 mA
4-5	voltage input 0÷10 V
6	output +24 V (in relation to the 5-GND) of the integrated power supply of field transducers
5-7	binary input (contact or voltage <24 V)
5-8	analog current output (0/4÷20 mA) or voltage output (0/2÷10 V)
PRG	programming connection for cooperation with the programmer ( <b>only AR955</b> )
9-10 (7-8 for AR600)	serial interface RS485 (MODBUS-RTU transmission protocol), <b>in AR600</b> interface RS485 excludes an analog output and a binary input (in accordance with the order code)
12-13	power supply input 230 VAC or 24 VAC/DC
14-15-16	relay output P1 or SSR1 (14-15), <b>for AR600</b> output P2 or SSR2: 14-15
17-18	relay output P2 or SSR2 (14-15), <b>for AR600</b> output P1 or SSR1:
19-20 (except for AR600)	relay output P3 or SSR3

a.1) AR640, AR650, AR680 - clamp terminal description Table 7

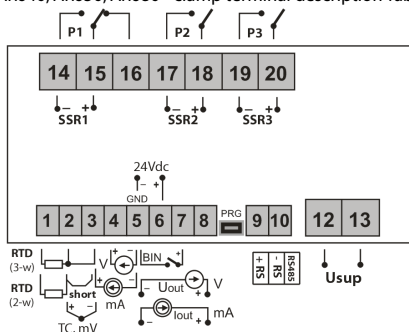

a.2) AR600 - clamp terminal description Table 7

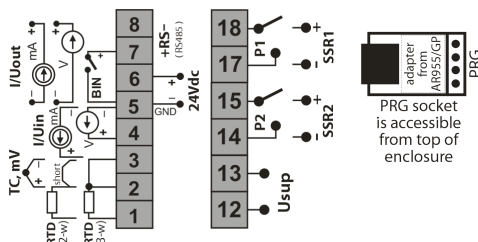

a.3) AR690, AR630 - Clamp terminal description Table 7 (in AR630 the PRG connection is available on the board of the display)

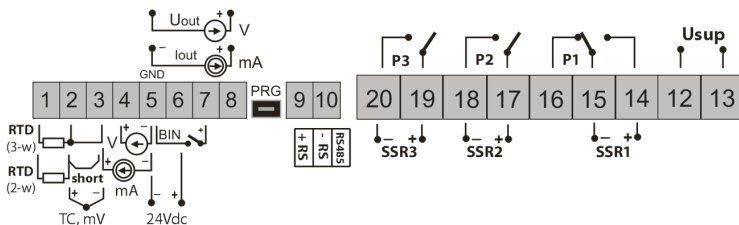

### NOTE:

In the **AR630** controller, in order to install the cabling, the following guidelines must be observed:

- remove the 4 screws in the front board and take it off the device
- fix the device to the ground with 4 screws in the fixing holes
- remove the screw in the display board and carefully slide the board from the mounting seats
- the connectors for signal wires, power supply, and transmitter outputs become accessible
- the electric cables must be inserted into the enclosure through cable glands
- after the installation is complete, assemble the device in the reverse order
- in order to achieve the IP65 rating, the nuts of the cable glands and the enclosure cover must be tightened precisely
- in order to avoid any mechanical and electrostatic damage, one must be very careful when handling the display board.

a.4) AR660 - description of clamp terminals Table 7

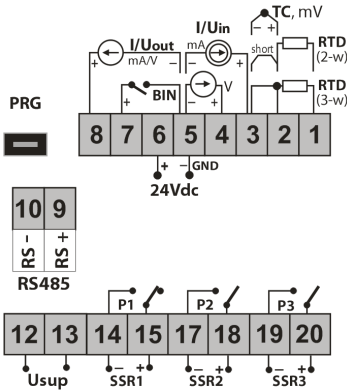

**NOTE:**

For connecting the device with a computer through the **PRG** socket, use only the **AR955** programmer (for AR600 with an optional adapter). A connection made with a regular USB cable may cause damage to the equipment.

b) connection of a 2- and 3-wire transducer (I<sub>out</sub> - output current, U<sub>out</sub> - output voltage)

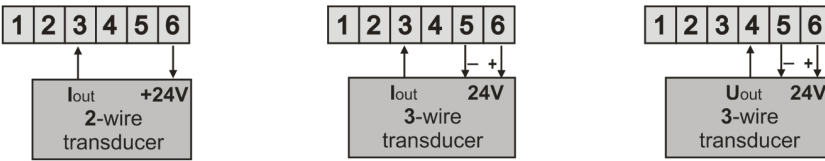

**8. IMPORTANT COMMENTS PERTAINING TO OPERATION** - use of suppression systems

If an inductive load (a contactor coil or a transformer) is connected to the contacts of a relay, then when the contacts open overvoltage and electric arc occurs frequently, caused by a discharge of the energy gathered in the induction. The particularly negative consequences of such overvoltages include reduced service life of contactors and relays, damage to semiconductors (diodes, thyristors, and triacs), damage to or interference with the control and measurement systems, and emission of electromagnetic field that interferes with local devices. In order to avoid such consequences, the overvoltages must be reduced to a safe level. The simplest method is to connect an appropriate suppression module **directly** to the terminals of the inductive load. Generally speaking, appropriate types of suppression circuits must be selected for each type of inductive load. Modern contactors are generally fitted with appropriate factory-made suppression circuits. If such circuits are lacking, a contactor with an integrated suppression system must be purchased. Temporarily, the load can be shunted with an RC system, e.g. R=47 Ω/1 W and C=22 nF/630 V. The suppression circuit must be connected to the inductive load terminals. The use of a suppression circuit limits burning of relay contacts in the controller and reduces the likelihood of their sticking.

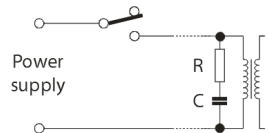







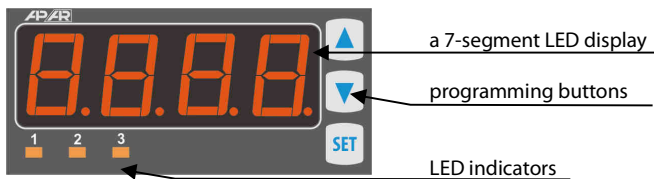



## 9. FUNCTIONS OF BUTTONS AND LED DIODES. MINIMUM AND MAXIMUM VIEW.





Description of the front side using the example of the AR650





a) button functions in the measurement display mode

Button	Description [and marking in the contents of the instructions]
 or 	<b>[UP]</b> or <b>[DOWN]</b> : changes the preset value for output 1 (parameter 9: <b>SEEL</b> , or 26: <b>HSEEL</b> when output 1 is in the manual mode, see chapters 11 and 13.7)
	<b>[SET]</b> : - output in the quick access menu (chapter 12)
 + 	<b>[UP]</b> and <b>[DOWN]</b> (at the same time): input in the parameter configuration menu (after hold time longer than 1 s). If parameter 29: <b>PPro</b> = <b>on</b> (password protection is activated) enter the access code (chapter 11)
 + 	<b>[SET]</b> and <b>[UP]</b> : - displays the saved <b>MAXIMUM VALUE</b> of the measurement - deletes the maximum value of the measurement (after hold time > 6 s)
 + 	<b>[SET]</b> and <b>[DOWN]</b> : - displays the saved <b>MINIMUM VALUE</b> of the measurement - deletes the minimum value of the measurement (after hold time > 6 s)

b) button functions in the parameter configuration menu and the quick access menu (chapters 11 and 12)

Button	Description [and marking in the contents of the instructions]
	<b>[SET]</b> : - edits the current parameter (the value blinks on the display) - approves and saves the edited parameter value
 or 	<b>[UP]</b> or <b>[DOWN]</b> : - moves to the next or previous parameter - changes the value of the edited parameter
 + 	<b>[UP]</b> and <b>[DOWN]</b> (simultaneously): - cancels the change of the edited value (and displays the parameter name again) - returns to the measurement display mode (after hold time >0.5 s)

c) functions of the LED signaling diodes

LED indicators [designation]	Description
   [1] [2] [3]	signals switching on of outputs P1/SSR1, P2/SSR2, and P3/SSR3

## 10. BINARY INPUT

Binary input **BIN** performs a function that is programmable with parameter 30: **Func** (chapter 11). The binary input works with the bi-stable signal i.e. the supplied signal (voltage or switch) must be permanent (on/off type). Activation of the function is indicated by appropriate messages on the display (described below in Table 10).

Table 10. Available **BIN** input functions

Source	Description (depending on the value of parameter 30: <b>Func</b> )	Message	
	<b>Func</b> = none	the <b>BIN</b> input is inactive (factory setting)	-
	<b>Func</b> = SET1	step-wise change of the preset value for the P1/SSR1 output (day = 9: SET1 /night = 16: SET3)	SET1 / SET3
	<b>Func</b> = bloc	keypad block	bloc / boFF
	<b>Func</b> = hAN1	unconditional manual mode for the P1/SSR1 output (chapter 13.7)	hANd / hoFF
	<b>Func</b> = hAN2	unconditional manual mode for the P2/SSR2 output	hANd / hoFF
	<b>Func</b> = hAN3	unconditional manual mode for the P3/SSR3 output	hANd / hoFF
	<b>Func</b> = hANR	unconditional manual mode for the analog output	hANd / hoFF
	<b>Func</b> = StSP	control start/stop (applies to all outputs)	StAR / StOP
	<b>Func</b> = hold	stopping the display indications (HOLD function)	hdOF / hold

## 11. SETTING OF THE CONFIGURATION PARAMETERS

All the controller's configuration parameters are saved in a non-volatile (permanent) internal memory.

When the device is switched on for the first time, an error message may be shown in the display due to the lack of a sensor or the fact that the connected sensor is not factory-programmed. In such an event, the proper sensor or analog signal must be connected and the configuration must be programmed.

There are two parameter configuration methods:

### 1. From the film keypad located on the front panel of the device:

- from the mode where the input measurements are displayed in the configuration menu (press the **[UP]** and **[DOWN]** buttons simultaneously for more than 1 s) If parameter 29: **PRPo** = on (password protection is activated) then the display shows the message **code**, and then **0000** with the first digit blinking, use buttons **[UP]** or **[DOWN]** to enter the password (default parameter 28: **PASS** = **1111**), move to successive positions or approve the code using the **[SET]** button
- after entering the configuration menu (with message **CONF**) the display shows the mnemonic name of the parameter ( **inp** <-> **FILt** <-> **dob** <-> etc.)
- by pressing the **[UP]** button, one can move to the next parameter, and by pressing the **[DOWN]** button - to the previous parameter (the list of the configuration parameters is presented in Table 11)
- to change the value of the current parameter, press briefly the **[SET]** button (the parameter blinks in the edition mode)
- use buttons **[UP]** or **[DOWN]** to change the value of the edited parameter
- approve the changed value of the parameter by pressing the **[SET]** button; cancel it by pressing the **[UP]** and **[DOWN]** buttons (simultaneously and for a short moment); then the parameter name is displayed again
- to exit the configuration: press the **[UP]** and **[DOWN]** buttons simultaneously for a long moment or wait approx. 2 minutes

### 2. Use the RS485 or the PRG port (AR955 programmer) and the ARSOFT-WZ1 software (chapter 15):

- connect the controller to a computer port and start and configure the ARSOFT-WZ1 application;
- after the connection has been established, the current measured value is displayed in the window of the software
- setting and viewing of the device parameters is possible in the parameter configuration window
- new parameter values must be approved with the **Approve changes** button
- the current configuration can be saved in a file or set using values read from a file

- a file with finished configuration can also be created using the ARSOFT-WZ4 software (chapter 15)

**NOTE:** 

- before disconnecting the device from a computer, press the **Disconnect device** button (ARSOFT-WZ1)
- in the event of no response:
  - in the **Program options** check the configuration of the port and the **MODBUS Address of the device**
  - make sure that the serial port drivers in the computer have been properly installed for the RS485 converter or the AR955 programmer
  - disconnect for a few seconds and then reconnect the RS485 converter or the AR955 programmer
  - restart the computer

In the event of indications different than the actual value of the input signal, the zero and the sensitivity of a sensor can be tuned: parameters 36: **RL0** (zero) and 37: **RLS** (sensitivity).

To restore the factory settings, when the power supply is switched on press buttons **[UP]** and **[DOWN]** and hold them until the password menu appears (**Code**), and then enter the following code **9112**. As an alternative, a file with default configuration can be used in the ARSOFT-WZ1 software.

**NOTE:** 

Do not perform configuration of the device with the keypad and through the serial interface (RS485 or AR955) at the same time.

Table 11. List of configuration parameters

Parameter	Range of variability of the parameter and description		Settings Factory
0: <b>mP</b> Type of measurement input	<b>PL</b>	thermoresistance sensor (RTD) Pt100 (-200 ÷ 850°C)	<b>PL</b>
	<b>n</b>	thermoresistance sensor (RTD) Ni100 (-50 ÷ 170°C)	
	<b>PL5</b>	thermoresistance sensor (RTD) Pt500 (-200 ÷ 620°C)	
	<b>PL10</b>	thermoresistance sensor (RTD) Pt1000 (-200 ÷ 520°C)	
	<b>tc-J</b>	thermoelectric sensor (thermocouple) type J (-40 ÷ 800°C)	
	<b>tc-K</b>	thermoelectric sensor (thermocouple) type K (-40 ÷ 1,200°C)	
	<b>tc-S</b>	thermoelectric sensor (thermocouple) type S (-40 ÷ 1,600°C)	
	<b>tc-B</b>	thermoelectric sensor (thermocouple) type B (-300 ÷ 1,800°C)	
	<b>tc-R</b>	thermoelectric sensor (thermocouple) type R (-40 ÷ 1,600°C)	
	<b>tc-T</b>	thermoelectric sensor (thermocouple) type T (-25 ÷ 350°C)	
	<b>tc-E</b>	thermoelectric sensor (thermocouple) type E (-25 ÷ 820°C)	
	<b>tc-N</b>	thermoelectric sensor (thermocouple) type N (-35 ÷ 1,300°C)	
	<b>4-20</b>	current signal 4 ÷ 20 mA	
	<b>0-20</b>	current signal 0 ÷ 20 mA	
	<b>0-10</b>	voltage signal 0 ÷ 10 V	
	<b>0-60</b>	voltage signal 0 ÷ 60 mV	
	<b>RES</b>	resistance signal 0 ÷ 2,500 Ω	
<b>REFR</b>	remote input from the RS485 or PRG port, chapter 17, Table 17.6		

1: <b>Filt</b> filtration (1)	<b>1 ÷ 20</b>	digital filtration of measurements (response time)	<b>5</b>
2: <b>dot</b> position of the point/resolution	<b>0</b>	no point (2) or 1°C for temperature	<b>1</b> (0.1 °C)
	<b>1</b>	<b>0.0 (2)</b> or resolution 0.1 °C for temperature	
	<b>2</b>	<b>0.00 (2)</b>	
	<b>3</b>	<b>0.000 (2)</b>	
3: <b>L01</b> lower limit 1 or bottom of the indication range (2)	<b>4999 ÷ 1800</b>	lower setting limit for the preset value 9: <b>SEt1</b>	<b>4999</b> °C
	<b>4999 ÷ 9999</b>	indication 0/4 mA, 0 V, 0 Ω - start of the input scale (2)	
4: <b>H11</b> upper limit 1 or top of the indication range (2)	<b>4999 ÷ 1800</b>	upper setting limit for the preset value 9: <b>SEt1</b>	<b>8500</b> °C
	<b>4999 ÷ 9999</b>	indication for 20 mA, 10 V, 60 mV, 2,500 Ω - end of the input scale (2)	
5: <b>L02</b> lower limit 2	<b>4999 ÷ 1800</b>	lower setting limit for the preset value 13: <b>SEt2</b>	<b>4999</b> °C
	3: <b>L01</b> ÷ 4: <b>H11</b>	lower setting limit for 9: <b>SEt1</b> and 13: <b>SEt2</b> (2)	
6: <b>H12</b> upper limit 2	<b>4999 ÷ 1800</b>	upper setting limit for the preset value 13: <b>SEt2</b>	<b>8500</b> °C
	3: <b>L01</b> ÷ 4: <b>H11</b>	upper setting limit for 9: <b>SEt1</b> and 13: <b>SEt2</b> (2)	
<b>MAIN OUTPUT CONFIGURATION (P1/SSR1) - chapter 13 (13.2)</b>			
7: <b>Fto1</b> failure status of output 1 (3)		output status in the case of lack of or damage to the measurement sensor (signal): <b>noCh</b> = no change, <b>oFF</b> = off, <b>on</b> = on	<b>noCh</b>
8: <b>out1</b> function of output 1		<b>oFF</b> = off, <b>hAnd</b> = manual mode, <b>he</b> = heating, <b>co</b> = cooling	<b>he</b>
9: <b>SEt1</b> preset value 1		applies to output 1, changes in scope 3: <b>L01</b> ÷ 4: <b>H11</b> or 5: <b>L02</b> ÷ 6: <b>H12</b> (2)	<b>1800</b> °C
10: <b>H</b> hysteresis of output 1 or PID tuning zone		hysteresis or insensitivity zone of PID tuning in mode <b>Auto</b> , chapter 13.5 <b>0.0</b> ÷ <b>9999</b> °C or <b>0</b> ÷ <b>9999</b> units (2)	<b>1.0</b> °C
<b>AUXILIARY OUTPUTS CONFIGURATION (P2/SSR2 and P3/SSR3) - chapter 13</b>			
11: <b>Fto2</b> failure status of output 2 (3)		output status in the case of lack of or damage to the measurement sensor (signal): <b>noCh</b> = no change, <b>oFF</b> = off, <b>on</b> = on	<b>noCh</b>
12: <b>out2</b> function of output 2 (chapter 13.2)		<b>oFF</b> = off, <b>hAnd</b> = manual mode, <b>he</b> = heating, <b>co</b> = cooling, <b>band</b> or <b>band</b> = band 2* <b>SEt2</b> around <b>SEt1</b> , <b>dev</b> or <b>dev</b> = deviation from <b>SEt1</b>	<b>he</b>
13: <b>SEt2</b> preset value 2		applies to output 2, changes in scope 5: <b>L02</b> ÷ 6: <b>H12</b> (2)	<b>1800</b> °C
14: <b>H2</b> hysteresis of output 2		<b>0.0</b> ÷ <b>9999</b> °C or <b>0</b> ÷ <b>9999</b> units (2)	<b>1.0</b> °C
15: <b>out3</b> function of output 3 (chapter 13.2)		<b>oFF</b> = off, <b>hAnd</b> = manual mode, <b>he</b> = heating, <b>co</b> = cooling, <b>band</b> or <b>band</b> = band 2* <b>SEt3</b> around <b>SEt1</b> , <b>dev</b> or <b>dev</b> = deviation from <b>SEt1</b>	<b>oFF</b>
16: <b>SEt3</b> preset value 3		applies to output 3, <b>1999</b> ÷ <b>1800</b> or <b>4999</b> ÷ <b>9999</b> units (2)	<b>1800</b> °C
<b>ANALOG OUTPUT CONFIGURATION (chapter 13.3)</b>			
17: <b>RA2A</b> type of analog output		depending on the order code: for current output <b>0-20</b> or <b>4-20</b> mA, for voltage output <b>0-10</b> or <b>0-10</b> V	<b>0-20</b> mA ( <b>0-10</b> V)
18: <b>outA</b> function of analog output		<b>oFF</b> = off, <b>hAnd</b> = manual mode, <b>retr</b> = retransmission of measurement, <b>cont</b> = control output, a detailed description is provided in chapter 13.3	<b>oFF</b>
19: <b>RtoA</b> lower indication for retransmission		start of the output scale - for output signal value 0/4 mA or 0/2 V (the parameter is active only for measurement retransmission when 18: <b>outA</b> = <b>retr</b> )	<b>0.0</b> °C

20: <b>R-H</b> upper indication for retransmission	end of the output scale - for output signal value 20 mA or 10 V (the parameter is active only for measurement retransmission when 18: <b>oVtR</b> = <b>rEtr</b> )		<b>1000</b> °C	
<b>CONFIGURATION OF THE PID ALGORITHM AND THE MANUAL MODE</b>				
21: <b>tune</b> type of PID tuning	<b>off</b> = off, <b>Auto</b> = automatic selection (continuous tuning), <b>SETP</b> = run-up (quick) method, <b>osc</b> = oscillation (slower) method, chapter 13.5		<b>off</b>	
22: <b>Pb</b> range of PID proportionality	<b>00</b> ÷ <b>1000</b> or <b>0</b> ÷ <b>9999</b> units ( <b>2</b> ), <b>0</b> - switches off the PID's action, a description of the PID algorithm and associated topics can be found in chapters 13.4 ÷ 13.6		<b>00</b> °C	
23: <b>ti</b> PID integration time constant	<b>0</b> ÷ <b>9999</b> s	PID algorithm doubling time <b>0</b> switches off the integrating component of the PID algorithm	<b>0</b> s	
24: <b>td</b> PID differentiation time constant	<b>0</b> ÷ <b>999</b> s	PID algorithm lead time <b>0</b> switches off the differentiating component of the PID algorithm	<b>0</b> s	
25: <b>tc</b> impulse period	<b>0</b> ÷ <b>999</b> s	for bi-state outputs (1, 2, 3) in the manual mode and the PID	<b>9</b> s	
26: <b>MAN</b> preset value of the manual mode	<b>0</b> ÷ <b>100</b> % 1% step	control value for outputs in the manual mode, applies to all outputs (1, 2, 3, and the analog output), chapter 13.7	<b>500</b> %	
<b>ACCESS, DISPLAY, AND COMMUNICATION OPTIONS AND OTHER CONFIGURATION PARAMETERS</b>				
27: <b>SEt</b> value change block <b>SEt1</b> , <b>SEt2</b>	<b>off</b> = no block, <b>SEt1</b> = block of parameter 9: <b>SEt1</b> , <b>SEt2</b> = block 13: <b>SEt2</b> , <b>both</b> = simultaneous block of changes to parameters 9: <b>SEt1</b> and 13: <b>SEt2</b>		<b>off</b>	
28: <b>PASS</b> password	<b>0000</b> ÷ <b>9999</b>	password for the parameter configuration menu	<b>1111</b>	
29: <b>PPr</b> protection of the configuration with a password	<b>off</b>	entry into the configuration menu is <b>not</b> password-protected	<b>on</b>	
	<b>on</b>	entry into the configuration menu is password-protected		
30: <b>Func</b> the <b>BIN</b> input function (chapter 10)	<b>none</b>	the <b>BIN</b> input is inactive	<b>none</b>	
	<b>SEt3</b>	change of the preset value (day/night) for output 1		
	<b>blck</b>	keypad block		
	<b>MAN1</b>	unconditional manual mode for output 1 (P1/SSR1)		
	<b>MAN2</b>	unconditional manual mode for output 2 (P2/SSR2)		
	<b>MAN3</b>	unconditional manual mode for output 3 (P3/SSR3)		
	<b>MANR</b>	unconditional manual mode for the analog output		
	<b>hold</b>	stopping the display indications (HOLD function)		
31: <b>br id</b> illumination brightness	<b>50</b> ÷ <b>100</b> %	brightness of the display, a 50% increase	<b>100</b> %	
32: <b>col0</b> basic color ( <b>4</b> )	<b>GrE</b> = green, <b>YEL</b> = yellow, <b>orAn</b> = pink, <b>AmB</b> = amber, <b>rEd</b> = red, <b>col0</b> = basic (only for 33: <b>Rcol</b> ) (33: <b>Rcol</b> - display color for connected outputs 1, 2, or 3)		<b>rEd</b>	
33: <b>Rcol</b> alarm color ( <b>4</b> )			<b>col0</b>	
34: <b>Addr</b> MODBUS-RTU address	<b>1</b> ÷ <b>247</b>	individual address of the device in the RS485 network (chapter 17)	<b>1</b>	
35: <b>br</b> speed for RS485	<b>24</b> kbit/s	<b>48</b> kbit/s	<b>96</b> kbit/s	<b>192</b> kbit/s
	<b>96</b> kbit/s	<b>576</b> kbit/s	<b>1152</b> kbit/s	
36: <b>ARL0</b> calibration of the zero	zero offset for measurements: <b>-500</b> ÷ <b>500</b> °C or <b>-500</b> ÷ <b>500</b> units ( <b>2</b> )		<b>00</b> °C	
37: <b>ARL0</b> gain	<b>850</b> ÷ <b>1150</b> %	Slope calibration (sensitivity) for measurements	<b>1000</b> %	

**Notes:** (1) – for **FILT** = **1** the response time is equal to 0.25 s, for **FILT** = **20** it is equal to at least 3 s. A higher degree of filtration means a more "smooth" measured value and a longer response time, which is recommended in the case of turbulent measurements (e.g. water temperature in a boiler)

(2) – applies to analog inputs ( mA, V, mV,  $\Omega$  ), when 3: **LO** is greater than 4: **HHi** results in a reverse characteristic (negative inclination)

(3) – the parameter also defines the state of the output outside of the measurement range

(4) – a non-significant parameter in AR600, AR640, AR660, and AR690 (as the display is a single-color one)

## 12. QUICK ACCESS MENU

In the measurement mode (when the measured value is displayed), it is possible to immediately access certain configuration parameters and functions without the need to enter a password. This possibility is offered by the quick menu, which can be accessed by pressing the **[SET]** button. The parameter is selected and edited in the same way as described above (in chapter 11). The list of elements that are accessible in the quick configuration menu is shown in Table 12.

Table 12. List of elements accessible in the quick configuration menu.

Element	Description
<b>SEt1</b>	preset value 1 (parameter 9: <b>SEt1</b> ), optional element - unavailable when parameter 8: <b>out1</b> = <b>hAnd</b> , changes blocked during selection of parameters (tuning) of the PID (chapter 13.5) and in the mode of replacement of the preset value 1 to <b>SEt3</b> (chapter 10)
<b>SEt2</b>	preset value 2 (13: <b>SEt2</b> ), optional element - unavailable when parameter 12: <b>out2</b> = <b>oFF</b> or <b>hAnd</b>
<b>SEt3</b>	preset value 3 (16: <b>SEt3</b> ), optional element - unavailable when parameter 15: <b>out3</b> = <b>oFF</b> or <b>hAnd</b>
<b>t-St</b>	start/stop of PID tuning (chapter 13.5), optional element - unavailable when parameter 21: <b>tunE</b> = <b>oFF</b>
<b>MSEt</b>	preset value of the manual mode (26: <b>MSEt</b> ), optional element - available for outputs in the manual operation mode

## 13. OUTPUT OPERATION CONFIGURATION

The programmable architecture of the controller enables using it in many fields and applications. Before the operation of the device starts, it is necessary to set the parameters according to specific requirements (chapter 11). A detailed description of configuration of the operation of outputs is given in chapters 13.1÷ 13.7. The status of the outputs can also be indicated by a variable color of the display (parameter 33: **RCOL**, only in AR630, AR650, and AR680). The default (factory) configuration is the following: outputs 1 and 2 are in the ON/OFF configuration mode with hysteresis, output 3 and the analog output are switched off (Table 11, *Factory settings* column).

### 13.1. CHANGING THE PRESET OUTPUT VALUES

In the measurement mode, the display shows the value being measured. The simplest way to change the preset value for output 1 (parameter 9: **SEt1** or 26: **MSEt** when output 1 is in the manual mode) is to use the **[UP]** button or the **[DOWN]** button. In the case of the other outputs, the quick menu can be used (chapter 12). As an alternative, it is possible to change the preset value in the parameter configuration mode (using the methods described in chapter 11).

### 13.2. TYPES OF OUTPUT CHARACTERISTICS

The mode of operation of each output is programmed using parameters 8: **out1**, 12: **out2** and 15: **out3**, chapter 11, Table 11.

a) basic operating characteristics of outputs

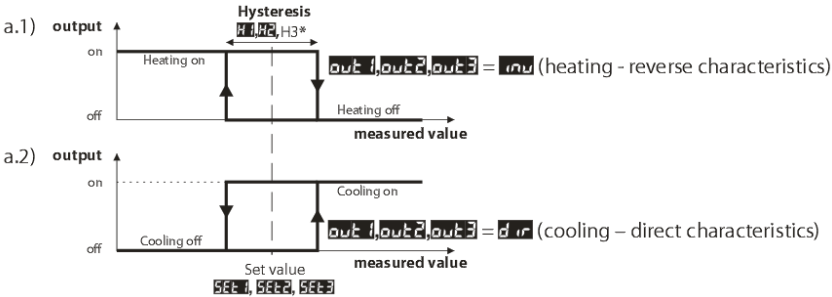

b) additional operating characteristics of outputs (applies only to outputs 2 and 3)

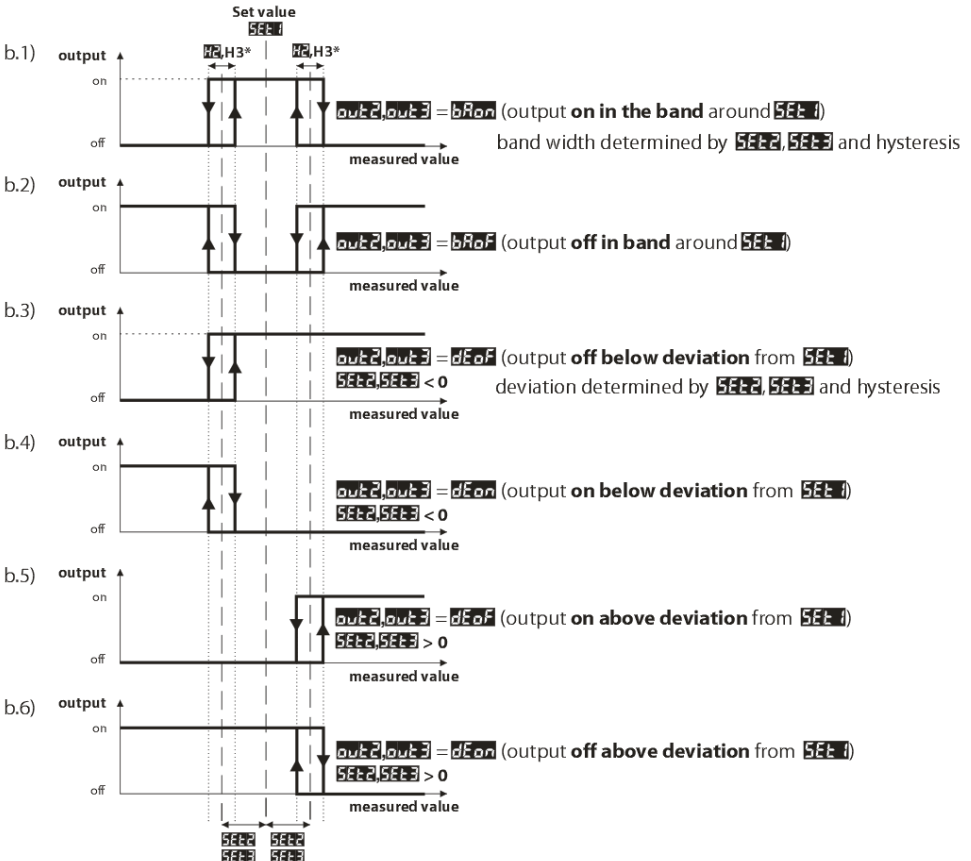

**NOTE:** \* H3 is a constant value equal to 0.2 °C (2 units) and is not configurable

### 13.3. ANALOG OUTPUT

The standard of the output signal is determined by parameter 17:  $R-L-YP$  (chapter 11, table 11). The analog output can work in one of the following modes: retransmission of measurement (parameter 18:  $OUT-R = RETR$ ), manual mode (18:  $OUT-R = HAND$ ) and as an automatic control output (18:  $OUT-R = CONT$ ).

In the measurement retransmission mode, the output signal is proportional to the measured signal in the range set by parameters 19:  $R-L-a$  and 20:  $R-H$  (e.g. 0 mA for the measured value 0 °C when  $R-L-a = 0$  °C, 20 mA for 100 °C when  $R-H = 100$  °C and, as appropriate, 10 mA for the half of the range, i.e. 50 °C). In other words, the output working in the measurement retransmission mode enables conversion of the input signal to an output signal (in the range of indications  $R-L-a \div R-H$ ).

Manual operation (chapter 13.7) makes it possible to change the output signal in the range of 0 ÷ 100% with a 1% step.

In the control output mode, the control parameters and their functions are identical as in the case of output 1 (the applicable parameters are 7:  $F-t-a$ , 8:  $OUT-i$ , 9:  $SET-i$ , 10:  $P$  and the PID algorithm and tuning parameters).

In the control mode, the range of variability of the analog signal is continuous only for the PID algorithm (with regards to proportionality, chapter 13.4), in the case of ON-OFF control with hysteresis, the output assumes limit values (lower or upper, e.g. 0 mA or 20 mA), without intermediate values.

### 13.4. PID REGULATION

The PID algorithm enables achieving smaller control errors (e.g. temperature) than the ON-OFF method with hysteresis. However, the algorithm requires selecting the characteristic parameters for the specific controlled object (e.g. a furnace). In order to simplify the operation, the controller is provided with the advanced PID parameter selection functions described in chapter 13.5. Also, it is always possible to manually correct the settings (chapter 13.6).

The controller works in the PID mode when the proportionality range (parameter 22:  $Pb$ ) is not a zero value. The location of the proportionality range  $Pb$  in relation to the preset value  $SET-i$  is shown in drawings 13.4 a) and b). The impact of the integrating and differentiating components of PID regulation is determined by parameters 23:  $I$  and 24:  $D$ . Parameter 25:  $t_c$  determines the impulse period for output 1 (P1/SSR1). If the PID algorithm is implemented by the 0/4÷20 mA or 0/2÷10 V analog output, the  $t_c$  parameter is insignificant. Then the output signal may assume intermediate values from the entire range of variability of the output.

Regardless of the type of the output, the correction of its state always takes place every 1 s.

The principle of P-type regulation (proportional regulation) for output 1 is shown in figures d) and e) for the analog output figure c).

Fig. 13.4. Principle of the PID regulation:

- location of the proportionality range  $Pb$  in relation to the preset value  $SET-i$  for heating ( $OUT-i = mA$ )
- location of the proportionality range  $Pb$  in relation to the preset value  $SET-i$  for cooling ( $OUT-i = V$ )
- state of the 0/4÷20 mA or 0/2÷10 V analog output
- filling coefficient for output 1 (P1/SSR1)
- state of output 1 (for the measured value within the proportionality range)

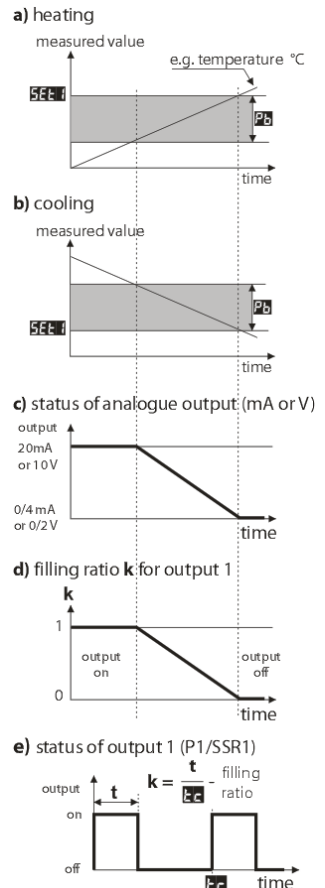



## 13.5. AUTOMATIC PID PARAMETER SELECTION

The first step to use the PID parameter selection function is to choose the type of tuning (parameter 21: **Func**, chapter 11). The tuning is started automatically when the regulation starts (after the power supply is switched on, and by the **BIN** binary input, when parameter 30: **Func = 55P**, chapter 10). Moreover, the tuning can be stopped (**off**), and then started (**on**) at any time using the **55t** function available in the quick menu (chapter 12).

During the tuning (when the display shows, alternately with the measured value, the message **Func**) the preset value must not be changed (9: **55t1** or 16: **55t3** when 30: **Func = 55t3**).

The value of parameter 21: **Func** determines the selection of the PID parameter selection method:

- a) 21: **Func = Auto** - automatic selection - the controller continuously checks if there are appropriate conditions for starting the tuning and tests the object in order to select the proper method. The algorithm continuously forces operation in the PID mode. The necessary condition for initiating the PID parameter selection procedure is that the current measured value must be located outside of the insensitivity zone defined as the sum of the values of parameter 22: **Pb** and 10: **H** in relation to the preset value 9: **55t1**, as shown in figure 13.5.

Figure 13.5. Location of the insensitivity zone for heating (8: **55t1 = 100**) and cooling (8: **55t1 = 0**)

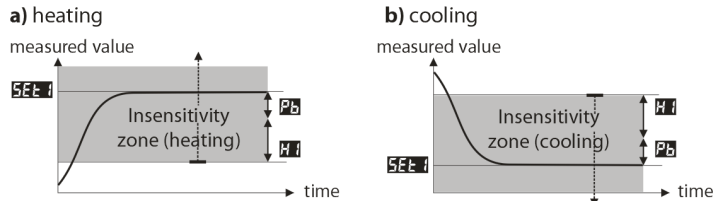

In order to avoid unnecessary activation of tuning, which may slow down the process, it is recommended to set the highest possible value of **H**, not less than 10÷30% of the range of variability of the process (e.g. the measured temperature). Testing of the object with temporary switchoff of the output and the **Func** message also takes place in the insensitivity band if sudden changes in the measured value or preset value are detected.

The selection of the parameter selection method depends on the nature of the initial conditions. In the case of a stabilized controlled value, the run-up (quick) method will be selected; in other cases, the oscillation method (slower) will be selected.

Automatic selection enables optimum selection of the PID parameters for the current conditions at the object, without the user's involvement. It is recommended for variable value regulation (disturbance of the conditions determined during the operation due to the change of, e.g. the preset value or the weight of the furnace batch).

- b) 21: **Func = 55EP** - selection of parameters in the run-up phase (response to step function). During determination of the object's characteristics, the algorithm does not cause any additional delay in reaching the preset value. This method is intended specifically for objects of stabilized initial value of the controlled value (e.g. temperature in a cold furnace). In order to avoid disturbing stabilized initial conditions, before the automatic tuning is switched on, the power supply of the operating element (e.g. a heater) should be switched off using an external connector or the regulation start/stop function should be used (**BIN** input). The power supply must be switched on immediately after the tuning is started, in the output switch-on delay phase. If the power supply is switched on later, an erroneous analysis of the object and improper selection of PID parameters will result.
- c) 21: **Func = 55c** - selection of parameters using the oscillation method. The algorithm consists in measuring the amplitude and the period of oscillation on a slightly lower level (in the case of heating; higher level - in the case of cooling) than the preset value, thus eliminating the risk of exceeding the target value at the object testing stage. During determination of the object's characteristics, the algorithm causes additional delays in reaching the preset value. This method is intended specifically for objects of unstable initial value of the controlled value (e.g. temperature in a hot furnace).

The algorithms described in items **b** and **c** comprise the following steps:

- delay of output switch-on (approx. 15 s) - time for switching on the power supply of the operating element (heating /cooling power, fan, etc.)
- determination of the object's characteristics;
- calculation and saving in the controller's permanent memory parameters 22: **Pb**, 23: **H**, 24: **Hd** and 25: **Ec**

- switching on the regulation with new PID settings;

Programmed interruption of automatic tuning **b** or **c** (with the message **ErrE**) may take place if the conditions are not met for

correct operation of the algorithm, such as:

- the initial value is higher than the preset value for heating or lower than the preset value for cooling;
- the maximum tuning time (4 hours) has been exceeded;
- the process value is changing too fast or too slowly.

It is recommended to restart the automatic tuning **b** or **c** after a significant change in the **SEt** threshold or the controlled object's parameters (e.g. the heating/cooling power, the batch weight, the initial temperature, etc.).

### 13.6. PID PARAMETER CORRECTION

The automatic tuning function correctly selects the PID regulation parameters for most processes; however, sometimes it may be necessary to correct them. Due to the strong correlation between those parameters, only one parameter should be changed and the impact of the change on the process should be observed:

- oscillations about the threshold - increase the range of proportionality **22: P<sub>B</sub>**, increase the integration time **23: I<sub>T</sub>**, decrease differentiation time **24: D<sub>T</sub>**, (or change by a half the impulse period of output 1, parameter **25: E<sub>T</sub>**)
- free response - decrease the range of proportionality **P<sub>B</sub>**, differentiation times **D<sub>T</sub>** and integration times **I<sub>T</sub>**
- over-regulation - increase the range of proportionality **P<sub>B</sub>**, differentiation times **D<sub>T</sub>** and integration times **I<sub>T</sub>**
- instability - increase the integration time **I<sub>T</sub>**.

### 13.7. MANUAL AND REMOTE CONTROL FUNCTION

The manual mode enables setting the value of the output signal in the entire range of its variability (0-100%), thus enabling operation in an open regulation loop (no automatic coupling between the measured value and the output signal). Manual operation is available individually for each output of the controller and is programmed using parameters **8: O<sub>U<sub>1</sub>E<sub>1</sub></sub>**, **12: O<sub>U<sub>2</sub>E<sub>2</sub></sub>**, **15: O<sub>U<sub>3</sub>E<sub>3</sub></sub>** and **18: O<sub>U<sub>4</sub>E<sub>4</sub></sub>**, chapter 11, Table 11. Also, any output can be configured for quick (unconditional) manual mode controlled by the **BIN** binary input, by programming as appropriate parameter **30: F<sub>U<sub>1</sub>N<sub>1</sub></sub>** (chapter 10).

In the case of bi-state outputs (1, 2, 3), the change of the output signal consists in setting the filling coefficient (using parameter **26: H<sub>S<sub>E<sub>1</sub></sub>E<sub>1</sub></sub>**) with impulse period defined by parameter **25: E<sub>T</sub>**. The preset value of the manual mode **26: H<sub>S<sub>E<sub>1</sub></sub>E<sub>1</sub></sub>** = 0 stands for a permanently switched off output; value 100 stands for a permanently switched on output. The value can be set directly using the **[UP]** or **[DOWN]** button (only in the case of output 1, chapter 13.1) or using the quick menu (chapter 12), or alternatively, in the parameter configuration mode (from the film keypad or remotely using the RS485 or PRG serial port, chapters 11, 15 ÷ 17).

### 14. MESSAGE AND ERROR SIGNALING

a) measurement errors:

Code	Possible causes of error
<b>----</b>	- the measurement range of the sensor is exceeded from the top ( <b>----</b> ) or from the bottom ( <b>----</b> )
<b>----</b>	- the sensor is broken
<b>----</b>	- the sensor that is connected is different than the one that is set in the configuration (chapter 11, parameter <b>0: I<sub>1</sub>R<sub>P</sub></b> )

b) temporary messages and errors (one-time and recurring):

Code	Description of message
<b>Code</b>	mode of entering the password for access to the configuration parameters, chapter 11
<b>Err</b>	the password is invalid
<b>Conf</b>	access to the parameter configuration menu
<b>tune</b>	implementation of the PID automatic tuning function, chapter 13.5
<b>Errt</b>	automatic tuning error, chapter 13.5, error deletion using the <b>[UP]</b> and <b>[DOWN]</b> buttons (pressed simultaneously)
<b>Start / Stop</b>	regulation start/stop, chapter 10
<b>Set1 / Set2</b>	change of the preset value (day/night) for output 1, chapter 10
<b>Block / boFF</b>	keypad block on/off, chapter 10
<b>hand / hoFF</b>	unconditional manual mode on/off, chapter 10
<b>hold / hdoFF</b>	stopping of display indications (HOLD function) on/off, chapter 10
<b>save</b>	saving of factory parameter values (chapter 11)

## 15. CONNECTING THE CONTROLLER TO A COMPUTER AND AVAILABLE SOFTWARE

It may be useful (or necessary) to connect the controller to a computer in the following situations:

- remote monitoring and recording of current measurement data and process (status of the outputs) control
  - quick configuration of parameters, to include copying of settings to other controllers of the same type
- In order to establish communication over long distances, it is necessary to establish a connection in the RS485 standard with an available port in the computer (directly or using an RS485 converter), as described in chapter 16. Moreover, as a standard, the controllers are equipped with a PRG port which enables connecting to a computer using an AR955 programmer (without galvanic separation, cable length approx. 1.2 m). Both the programmer and the RS485 converter require installation of the supplied serial port drivers on the computer. Communication with devices is effected using a protocol compatible with MODBUS-RTU (chapter 17). The following applications are available (on a CD supplied with the AR955 programmer or to be downloaded from the Internet at [www.apar.pl](http://www.apar.pl), *Download* section, for operating systems Windows 2000/XP/Vista/7/8):

Name	Software description
<b>ARSOFT-WZ1</b> (free)	<ul style="list-style-type: none"> <li>- display of current measurement data from the connected device</li> <li>- configuration of the type of measurement input, the indication range, the regulation options, the alarms, the display, the communication, the access, etc. (chapter 11)</li> <li>- creation of a disk with a "cfg" extension, containing the current configuration of the parameters to be used again (duplication of configuration)</li> <li>- the program requires communication with the controller via the RS485 or PRG (AR955) port</li> </ul>
<b>ARSOFT-WZ4</b> (free)	<ul style="list-style-type: none"> <li>- creation on the disk of a ready configuration file with a "cfg" extension enabling programming the controller in the future using the RS485 interface or the AR955 and ARSOFT-WZ1 programmer</li> <li>- the program does not use communication with the</li> </ul>
<b>ARSOFT-WZ2 controller</b> (payable)	<ul style="list-style-type: none"> <li>- display and recording of current measurement data from a maximum of 30 channels at the same time (only from devices made by APAR)</li> <li>- the program requires communication with the controller via the RS485 or PRG (AR955) port</li> </ul>

The detailed descriptions of the aforementioned applications can be found in the installation folders.



Before establishing the connection, make sure that the MODBUS address of the device (parameter 34: **Address**) and the speed of transmission (35: **Baud**) are the same as the settings of the software. Moreover, in the software, set the number of the COM serial port in use (in the case of the RS485 converter or the AR955 programmer it is the number assigned by the operating system during installation of the drivers).

## 16. RS485 COMMUNICATION INTERFACE (acc. to EIA RS-485)

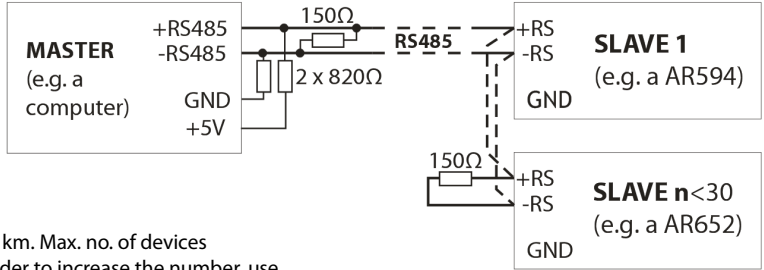

Max. RS485 cable length – 1 km. Max. no. of devices in the RS485 line – 30 – in order to increase the number, use RS485/RS485 amplifiers. Termination resistors when the MASTER is at the start of the line (fig. above):

- at the start of the line –  $2 \times 820 \Omega$  to the ground and +5 V MASTER and  $150 \Omega$  between the lines;
- at the end of the line –  $150 \Omega$  between the lines.

Termination resistors when the MASTER is in the middle of the line:

- at the converter –  $2 \times 820 \Omega$  to the ground and +5 V converter;
- at both ends of the line –  $150 \Omega$  each between the lines.

## 17. MODBUS–RTU SERIAL TRANSMISSION PROTOCOL (SLAVE)

Character format : 8 bits, 1 stop bit, no parity bit

Available functions : READ - 3 or 4, WRITE - 6

**Table 17.1. Claim frame format for the READ function** (frame length - 8 bytes):

address of the device	function 4 or 3	read register address: 0 ÷ 54 (0x0036)	number of read registers: 1 ÷ 55 (0x0037)	CRC check sum
1 byte	1 byte	2 bytes (HB-LB)	2 bytes (HB-LB)	2 bytes (LB-HB)

**Example 17.1.** Reading of a register with address 0: 0x01 - 0x04 - 0x0000 - 0x0001 - 0x31CA

**Table 17.2. Claim frame format for the WRITE function** (frame length - 8 bytes):

address of the device	function 6	write register address: 0 ÷ 54 (0x0036)	write register value	CRC check sum
1 byte	1 byte	2 bytes (HB-LB)	2 bytes (HB-LB)	2 bytes (LB-HB)

**Example 17.2.** Entry in a register with address 10 (0xA) with the 0 value: 0x01 - 0x06 - 0x000A - 0x0000 - 0xA9C8

**Table 17.3. Response frame format for the READ function** (minimum frame length - 7 bytes):

address of the device	function 4 or 3	number of bytes in the data field (max. 55*2=110 bytes)	data field - register value	CRC check sum
1 byte	1 byte	1 byte	2 ÷ 110 bytes (HB-LB)	2 bytes (LB-HB)

**Example 17.3.** Response frame for register value equal to 0: 0x01 - 0x04 - 0x02 - 0x0000 - 0xB930

**Table 17.4. Response frame format for the WRITE function** (frame length - 8 bytes):

copy of the claim frame for the WRITE function (Table 17.2)
---

**Table 17.5. Special response** (errors: function field = 0x84 or 0x83 in the case of the READ function and 0x86 in the case of the WRITE function):

Error code (HB-LB in the data field)	Error description
0x0001	non-existing register address
0x0002	wrong write register value
0x0003	improper function number

**Example 17.5.** Error frame for a non-existing read register address: 0x01 - 0x84 - 0x02 - 0x0001 - 0x5130

**Table 17.6. Map of registers for the MODBUS-RTU protocol**

Register address HEX (DEC)	Value (HEX or DEC)	Description of register and access type (R- read only register, R/W - read and write register)	
0x00 (0)	-1999 ÷ 19999	current measurement value	R/W
	-1999 ÷ 9999	value to be displayed for the remote input (when parameter 0: $mnP = rFRQ$ )	
0x01 (1)	650	device type identifier	R
0x02 (2)	100 ÷ 999	controller software (firmware) version	R
0x03 ÷ 0x05	0	not used or reserved	R
0x06 (6)	0 ÷ 7	current status of outputs 1, 2, 3: bits 0, 1, 2, bit=1 means the output is switched on	R
0x07 (7)	0 ÷ 20000	current state of the analog output (0 ÷ 20000 $\mu$ A or 0 ÷ 10000 mV)	R
0x08 (8)	-100 ÷ 700	thermocouple cold tip temperature (resolution 0.1 °C )	R
0x09 (9)	-1999 ÷ 19999	minimum measurement value	R
0x0A (10)	-1999 ÷ 19999	maximum measurement value	R
0x0B ÷ 0x10	0	not used or reserved	R
<b>Configuration parameters (chapter 11)</b>			
0x11 (17)	0 ÷ 17	parameter 0: $mnP$ type of measurement input (chapter 11)	R/W
0x12 (18)	1 ÷ 20	parameter 1: $FIL$ digital filtration of measurements (response time)	R/W
0x13 (19)	0 ÷ 3	parameter 2: $pos$ position of the point or resolution for temperature	R/W
0x14 (20)	-1999 ÷ 18000	parameter 3: $L1$ lower limit 1 or bottom of the indication range	R/W
0x15 (21)	-1999 ÷ 18000	parameter 4: $U1$ upper limit 1 or top of the indication range	R/W
0x16 (22)	-1999 ÷ 18000	parameter 5: $L2$ lower limit 2	R/W
0x17 (23)	-1999 ÷ 18000	parameter 6: $U2$ upper limit 2	R/W
0x18 (24)	0 ÷ 2	parameter 7: $Fst1$ failure status of output 1	R/W
0x19 (25)	0 ÷ 3	parameter 8: $out1$ function of output 1	R/W
0x1A (26)	-1999 ÷ 18000	parameter 9: $set1$ preset value 1	R/W
0x1B (27)	0 ÷ 9999	parameter 10: $H$ hysteresis of output 1 or PID tuning insensitivity zone	R/W

0x1C (28)	0 ÷ 2	parameter 11: <b>Flot</b> failure status of output 2	R/W
0x1D (29)	0 ÷ 10	parameter 12: <b>Out2</b> function of output 2	R/W
0x1E (30)	-1999 ÷ 18000	parameter 13: <b>Set2</b> preset value 2	R/W
0x1F (31)	0 ÷ 9999	parameter 14: <b>H</b> hysteresis of output 2	R/W
0x20 (32)	0 ÷ 10	parameter 15: <b>Out3</b> function of output 3	R/W
0x21 (33)	-1999 ÷ 18000	parameter 16: <b>Set3</b> preset value 3	R/W
0x22 (34)	0 ÷ 1	parameter 17: <b>RAOP</b> type of analog output	R/W
0x23 (35)	0 ÷ 3	parameter 18: <b>OutA</b> function of analog output	R/W
0x24 (36)	-1999 ÷ 18000	parameter 19: <b>RL</b> lower indication for retransmission	R/W
0x25 (37)	-1999 ÷ 18000	parameter 20: <b>RHL</b> upper indication for retransmission	R/W
0x26 (38)	0 ÷ 3	parameter 21: <b>TypnE</b> type of PID tuning	R/W
0x27 (39)	0 ÷ 18000	parameter 22: <b>PB</b> range of PID proportionality	R/W
0x28 (40)	0 ÷ 3600	parameter 23: <b>TI</b> PID integration time constant	R/W
0x29 (41)	0 ÷ 999	parameter 24: <b>TD</b> PID differentiation time constant	R/W
0x2A (42)	3 ÷ 360	parameter 25: <b>Im</b> impulse period	R/W
0x2B (43)	0 ÷ 100	parameter 26: <b>SetM</b> preset value of the manual mode	R/W
0x2C (44)	0 ÷ 3	parameter 27: <b>bSet</b> value change block <b>Set1</b> , <b>Set2</b>	R/W
0x2D (45)	0 ÷ 9999	parameter 28: <b>Pass</b> password	R/W
0x2E (46)	1 ÷ 2	parameter 29: <b>Prp</b> protection of the configuration with a password	R/W
0x2F (47)	0 ÷ 8	parameter 30: <b>FuncBIN</b> input function	R/W
0x30 (48)	20 ÷ 100	parameter 31: <b>br</b> brightness of the display, a 50% increase	R/W
0x31 (49)	0 ÷ 4	parameter 32: <b>Col</b> basic color	R/W
0x32 (50)	0 ÷ 5	parameter 33: <b>Rea</b> alarm color	R/W
0x33 (51)	1 ÷ 247	parameter 34: <b>Addr</b> MODBUS-RTU address in the RS485 network	R/W
0x34 (52)	0 ÷ 6	parameter 35: <b>ba</b> speed for RS485	R/W
0x35 (53)	-500 ÷ 500	parameter 36: <b>Zero</b> zero offset for measurements	R/W
0x36 (54)	850 ÷ 1150	parameter 37: <b>Slope</b> Slope calibration (sensitivity) for measurements	R/W

## **18. USER'S NOTES**

---

