

User Manual TRIME-GWs

TRIME-GWs with external GR-Probe



IMKO Micromodultechnik GmbH
Am Reutgraben 2
D - 76275 Ettlingen

Telefon: +49 - (0)7243 - 5921 - 0
Fax: +49 - (0)7243 - 90856
e-mail: info@imko.de
http: [//www.imko.de](http://www.imko.de)

User Manual for TRIME-GWs

Thank you for buying an IMKO moisture probe.

Please carefully read these instructions in order to achieve best possible results with your TRIME-GWs in-line moisture measurement system. Should you have any questions or suggestions regarding your new system after reading, please do not hesitate to contact our authorised dealers or IMKO directly. We will gladly help you.

List of Content:

1. Instrument Description TRIME-GWs	4
1.1.1. The patented TRIME® TDR-Measuring Method	4
1.1.2. TRIME® compared to other Measuring Methods	4
1.1.3. Areas of Application with TRIME-GWs and the GR-Probe	4
1.2. Mode of Operation	5
1.2.1. Measurement value collection with pre-check, average value and filtering	5
1.2.2. Temperature Measurement	5
1.2.3. Temperature compensation when working at high temperatures	5
1.2.4. Analogue Outputs	5
1.2.5. The serial RS485 and IMP-Bus interface	6
1.2.6. The IMP-Bus as a user friendly network system	6
1.2.7. Error Reports and Error Messages	6
2. Connectivity to TRIME-GWs	7
2.1.1. How to configurate SONO-probes to appropriate operating and calibration parameters?	8
2.2. Instrumentation TRIME-GWs with GR-Probe and SONO-VIEW	9
2.3. Electrical connection diagram with analogue outputs and SONO-VIEW	9
2.4. Connection Plug and Plug Pinning	10
2.4.1. Analogue Output 0..10V with a Shunt-Resistor	11
3. Installation in Practice	12
3.1.1. Monitoring during grain delivery	13
3.1.2. Manual control of the grain dryer	13
3.1.3. Automatic control of the grain dryer	13
4. Installation of the GR-Probe	14
4.1.1. Best installation conditions for TRIME-GWs inside a roof dryer	14
4.1.2. Best installation conditions for TRIME-GWs inside a rotary dryer	14
4.2. Installation at the exhaust Side of a Roof Drier	15
4.3. Installation directly in the exhaust Air Channel	16
4.4. Installation in Rotary Drier	16
4.5. Exchange of a GR-Probe	17
4.6. Installation of the Measurement Transformer TRIME-GWs	18
4.7. Protection of the Probe's MIL-Connector against Abrasion	18

5.	Initial Operation and Installation	19
5.1.	Adjustment Guidelines for relative Moisture Measurements in the heating Zone.....	19
5.2.	Adjustments for initial Operation	19
5.2.1.	Adjustment for plants with several TRIME-GWs.....	19
5.2.2.	Selection of the calibration curve Cal1 to Cal15	20
5.2.3.	Calibration curves with or without temperature compensation	21
5.3.	Calibration Curves Cal1 to Cal15.....	22
5.4.	Principle of Temperature Compensation.....	24
5.5.	Selection and application of the reference method	25
5.5.1.	Recording measurement data in trial operation	25
5.5.2.	Setting the calibration curve (adjustment)	26
5.5.3.	An example for wheat	26
5.6.	Creating a linear Calibration Curve for a specific Material.....	27
5.6.1.	Calculation for a linear 2-point calibration curve	27
5.6.2.	Calculation for a linear 1-point calibration curve	28
5.6.3.	Calculation for a non-linear calibration curve.....	28
5.7.	Configuration of the Measure Mode.....	29
5.7.1.	Operation Mode CA and CF at non-continuous Material Flow	29
5.7.2.	<i>Average Time</i> in the measurement mode CA and CF	31
5.7.3.	Filtering at material gaps in mode CA and CF	31
5.7.4.	Mode CC – automatic summation of a moisture quantity during one batch process	32
6.	Serial Connection to the SM-USB Module from IMKO	34
7.	Quick Guide for the Commissioning Software SONO-CONFIG	36
7.1.1.	Scan of connected SONO probes on the serial interface	36
7.1.2.	Configuration of serial SONO-interface	37
7.1.3.	Set analogue outputs of the SONO probe	37
7.1.4.	Configuration of Measure Mode.....	38
7.1.5.	Setting the precision of a single value measurement cycle.....	39
7.1.6.	Selection of the individual Calibration Curves	40
7.1.8.	Test run in the respective Measurement Mode	41
7.1.9.	“Measure” Run in Datalogging-Operation	41
7.1.10.	Basic Balancing in Air and Water	42
7.1.11.	Offsetting the material temperature sensor	43
7.1.12.	Compensation of the electronic temperature	43
8.	Technical Data TRIME-GWs	44
9.	Safety Notes	46

1. Instrument Description TRIME-GWs

1.1.1. The patented TRIME® TDR-Measuring Method

The TDR technology (Time-Domain-Reflectometry) is a radar-based dielectric measuring procedure at which the transit times of electromagnetic pulses for the measurement of dielectric constants, respectively the moisture content are determined.

TRIME-GWs consists of the measurement transformer TRIME-GWs and the GR-probe head. An integrated TRIME TDR measuring transducer of IMKO's SONO-series is installed into the TRIME-GWs casing. A high frequency TDR pulse (1GHz), passes along wave guides and generates an electro-magnetic field around these guides and herewith also in the material surrounding the probe. Using a new patented measuring method, IMKO has achieved to measure the transit time of this pulse with a resolution of 1 picosecond (1×10^{-12}), consequently determine the moisture and the conductivity of the measured material.

The established moisture content, as well as the conductivity, respectively the temperature, can either be uploaded directly into a SPC via two analogue outputs 0(4) ...20 mA or recalled via a serial RS485 interface.

1.1.2. TRIME® compared to other Measuring Methods

In contrary to conventional capacitive or microwave measuring methods, the TRIME® technology (Time-Domain-Reflectometry with Intelligent Micromodule Elements) offers precise measurement results which means more reliability at the production.

TRIME-TDR technology operates in the ideal frequency range between 600MHz and 1,2 GHz.

Capacitive measuring methods (also referred to as Frequency-Domain-Technology), depending on the device, operate within a frequency range between 5MHz and 40MHz and are therefore prone to interference due to disturbance such as the temperature and the mineral contents of the measured material. Microwave measuring systems operate with high frequencies >2GHz. At these frequencies, nonlinearities are generated which require very complex compensation. For this reason, microwave measuring methods are more sensitive in regard to temperature variation.

The modular TRIME technology enables a manifold of special applications without much effort due to the fact that it can be variably adjusted to many applications.

1.1.3. Areas of Application with TRIME-GWs and the GR-Probe

The TRIME-GWs with the 2-rod GR-probe is suited for measuring in different materials directly inside a grain dryer. The GR rod-probe requires a good flowability of the measured material in order to ensure that the material lies close to the rods when the material is flowing. For applications with badly flowing materials, the surface probes SONO-GS1 or SONO-VARIO LD could be a better solution.

The GR-probe head consists of PEEK. The special 2 meter long radar cable is made of PTFE. The GR-probe and the cable withstands temperatures up to 130° Celsius. But the temperature range for the TRIME-GWs measurement transformer should not be higher than 80°C.

1.2. Mode of Operation

1.2.1. Measurement value collection with pre-check, average value and filtering

TRIME-GWs measures internally at a rate of 100 measurements per seconds and issues the measurement value at a cycle time of up to 200 milliseconds at the analogue output. In these 200 milliseconds a probe-internal pre-check of the moisture values is already carried out, i.e. only plausible and physically pre-averaged measurement values are used for the further data processing. This increases the reliability for the recording of the measured values to a downstream control system significantly.

In the **Measurement Mode CS** (Cyclic-Successive), an average value is not accumulated and the cycle time here is 200 milliseconds. In the **Measurement Mode CA and CF** (Average), not the momentarily measured individual values are directly issued, but an average value is accumulated via a variable number of measurements in order to filter out temporary variations. These variations can be caused by inhomogeneous moisture distribution in the material surrounding the sensor head. The delivery scope of TRIME-GWs includes suited parameters for the averaging period and a universally applicable filter function deployable for currently usual applications. The time for the average value accumulation, as well as various filter functions, can be adjusted for special applications.

1.2.2. Temperature Measurement

A temperature sensor is installed in the rod tip of the GR probe which establishes the measurement of the material temperature. The temperature can optionally be issued at the analogue output 2.

1.2.3. Temperature compensation when working at high temperatures

Because the TRIME-GWs measurement transformer works in other temperature ranges as the GR-probe inside the dryer, it is necessary to compensate the electronic separately from the GR-probe. TRIME-GWs offers two possibilities for temperature compensation.

A) Temperature compensation of the internal SONO-electronic

Despite the TRIME-GWs electronic shows a generally low temperature drift, it is necessary to compensate a temperature drift in applications for measuring moisture inside a grain dryer. With this method of temperature compensation, a possible temperature drift of the SONO-electronic can be compensated. For standard applications in grain drying the compensation parameter is pre-setted to **TempComp=0.2**. For special applications it could be necessary to adjust this parameter. But it is to consider that it is necessary to make a Basic-Balancing of the TRIME-GWs in air and dry glass beads, if the parameter TempComp is changed to another value. The parameter TempComp can be changed with the software tool SONO-CONFIG, in the menu "**Calibration**" and the window "**TemperatureCompensation**".

B) Temperature compensation for the measured material

Water and special materials like maize, wheat and others, show a dependency of the dielectric permittivity when using TRIME-GWs at high temperature ranges. The dielectric permittivity is the raw parameter for measuring water content with TRIME-GWs. If special materials show this temperature drift, than it could be necessary to use a more elaborate temperature compensation. TRIME-GWs offers the possibility to set special temperature compensation parameters for every calibration curve Cal1 of Cal15 (see chapter "Selection of the individual calibration curve").

1.2.4. Analogue Outputs

The measurement values are issued as a current signal via the analogue output. With the help of the service program **SONO-CONFIG**, the TRIME-GWs can be set to the two versions for 0..20mA or 4..20mA. Furthermore, it is also possible to variably adjust the moisture dynamic range e.g. to 0-10%, 0-20% or **0-50%**. For a 0-10V DC voltage output, a 500R resistor can be installed in order to reach a 0..10V output.

Analogue Output 1: Moisture in % (0...50%, variable adjustable)

Analogue Output 2: Temperature 0....100°C, variable adjustable

For the analogue outputs 1 and 2 there are thus two adjustable options:

Analogue Output: (two possible selections)

0..20mA

4..20mA

Output Channel 1 and 2: (three possible selections)

1. **Moist, Temp.** Analogue output 1 for moisture, output 2 for temperature.

For analogue output 1 and 2 the moisture dynamic range and temperature dynamic range can be variably adjusted. The moisture dynamic range should not exceed 100%

Moisture Range:

Maximum: e.g. 50 for maize (Set in %)
Minimum: 0

Temp. Range:

Maximum: 70 °C
Minimum: 0 °C

1.2.5. The serial RS485 and IMP-Bus interface

TRIME-GWs is equipped with a standard RS485 as well as the IMP-Bus interface to set and readout individual parameters or measurement values. An easy to implement data transfer protocol enables the connection of several sensors/probes at the RS485-Interface. In addition, the TRIME-GWs can be directly connected via the modul SM-USB to the USB port of a PC, in order to adjust individual measuring parameters or conduct calibrations.

Please consider: The initial default setting of the serial interface is pre-setted for the IMP-Bus. To operate with the RS485 inside the TRIME-GWs, it is necessary to switch and activate the RS485 interface with help of the modul SM-USB.

In the download area of IMKO's homepage www.imko.de we publish the transmission protocol of TRIME-GWs.

1.2.6. The IMP-Bus as a user friendly network system

With external power supply on site for the SONO probes, a simple 2-wire cable can be used for the networking. By use of 4-wire cables, several probes can be also supplied with power.

Standard RS485-interfaces cause very often problems! They are not galvanically isolated and therefore raises the danger of mass grindings or interferences which can lead to considerably security problems. An RS485 network needs shielded and twisted pair cables, especially for long distances. Depending on the topology of the network, it is necessary to place 100Ohm termination resistors at sensitive locations. In practice this means considerable specialist effort and insurmountable problems.

The robust IMP-Bus ensures security. SONO-probes have in parallel to the standard RS485 interface the robust IMP-Bus which is galvanically isolated which means increased safety. The serial data line is isolated from the probe's power supply and the complete sensor network is therefore independent from single ground potentials and different grid phases. Furthermore the IMP-Bus transmit its data packets not as voltage signals, but rather as current signals which also works at already existing longer lines. A special shielded cable is not necessary and also stub lines are no problem.

1.2.7. Error Reports and Error Messages

TRIME-GWs is very fault-tolerant. This enables failure-free operation. Error messages can be recalled via the serial interface.

2. Connectivity to TRIME-GWs

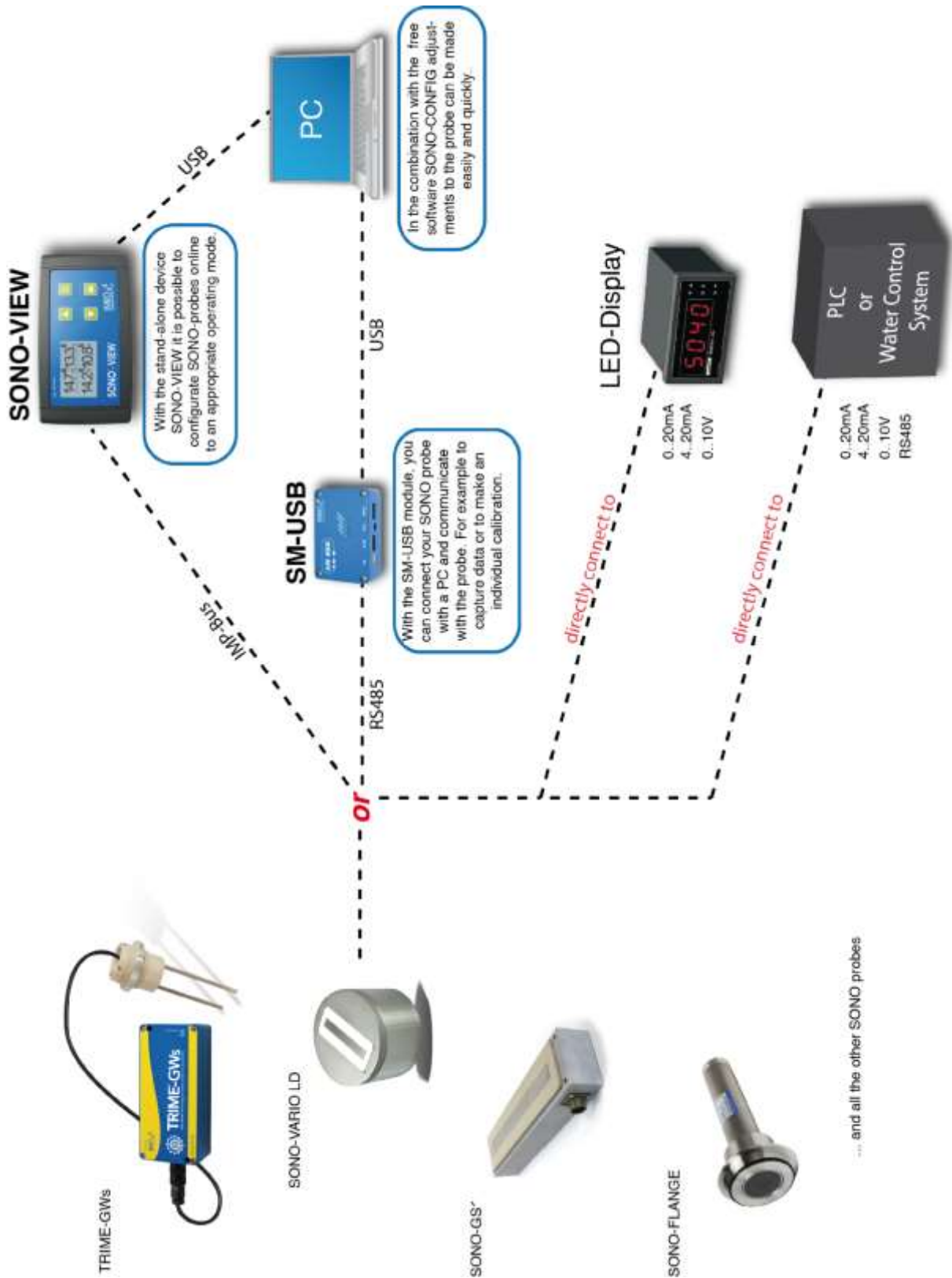

2.1.1. How to configurate SONO-probes to appropriate operating and calibration parameters?

TRIME-GWs is initially adjusted for the application for grain drying with the calibration curve Cal2, operation mode CF and 3 seconds average time. The analogue outputs are adjusted to 4..20mA. With this pre-adjustment TRIME-GWs can be installed direct in the heating zone, without further adjustments. For operation at the discharge hopper where an absolute moisture value is important, TRIME-GWs has to be adjusted to a suitable calibration curve Cal-x, depending on grain type and possibly to a zero-offset, depending on installation place.

There are two ways to configurate and adjust a SONO-probe:

A: Online Configuration via SONO-VIEW

With the stand-alone device SONO-VIEW it is possible to configurate SONO-probes online to an appropriate operating mode, without the need to connect the SONO-probe to a PC. The operating mode depends on the application like the moisture measurement under a silo flap, inside a dryer or mixer or on a conveyor belt. The SONO-probe can be adapted via the SONO-VIEW to the appropriate operating mode like: cyclic measurement, averaging, filtering, cumulating and other powerful operating parameters. Furthermore it is possible to select a calibration curve inside a SONO-probe with zero-offset setting. All configuration parameters are stored in a non-volatile memory inside the SONO-probe. This ensures that the analog output (e.g. 4-20mA) of the SONO-probe which could be connected in parallel to a PLC, responds directly to the setted configuration parameters.

B: Configuration via the SM-USB

The SONO-probe is connected via the SM-USB and the RS485-interface to a PC. With help of the software tool SONO-CONFIG it is possible to configurate SONO-probes to an appropriate operating mode. The operating mode depends on the application like the moisture measurement under a silo flap, inside a mixer or on a conveyor belt. The SONO-probe can be adapted to the appropriate operating mode like: cyclic measurement, averaging, filtering, cumulating and other powerful operating parameters. Furthermore it is possible to select a calibration curve inside a SONO-probe with zero-offset setting. All configuration parameters are stored in a non-volatile memory inside the SONO-probe. So the analog output (e.g. 4-20mA) of the SONO-probe which could be connected in parallel to a PLC, responds directly to the configuration parameters.

2.2. Instrumentation TRIME-GWs with GR-Probe and SONO-VIEW



The moisture display unit SONO-VIEW can be connected via the IMP-Bus.

2.3. Electrical connection diagram with analogue outputs and SONO-VIEW

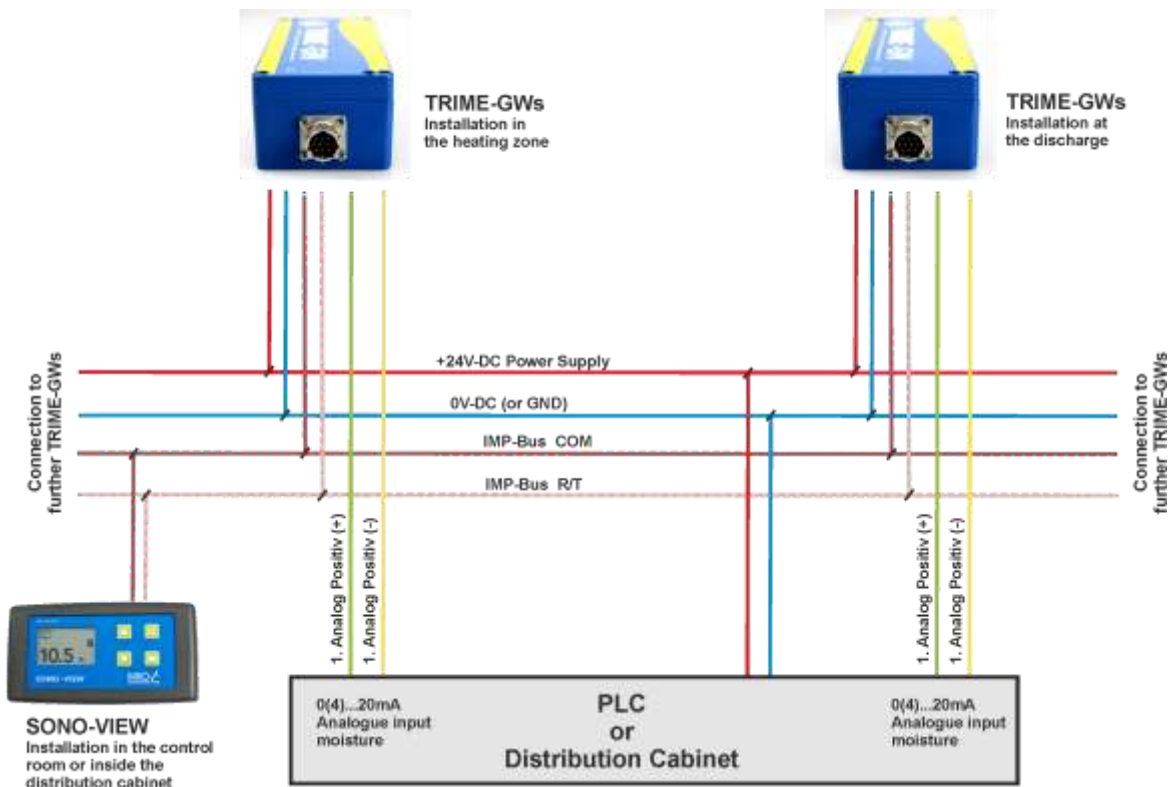

2.4. Connection Plug and Plug Pinning

TRIME-GWs is supplied with a 10-pole MIL flange plug.

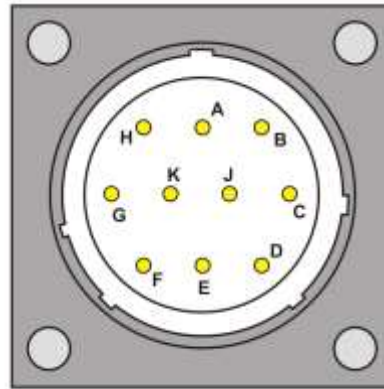

Assignment of the 10-pole MIL Plug and sensor cable connections:

Plug-PIN	Sensor Connections	Lead Colour	Lead Colour
A	+12V....24V Power Supply	red	red
B	0V Power Supply	Blue	Blue
D	1. Analogue Positive (+) Moisture	Green	Green
E	1. Analogue Return Line (-) Moisture	yellow	yellow
F	RS485 A	white	white
G	RS485 B	brown	brown
C	(rt) IMP-Bus	grey/pink	grey/pink
J	(com) IMP-Bus	blue/red	blue/red
K	2. Analogue Positive (+)	Pink	Pink
E	2. Analogue Return Line (-)	Grey	Grey
H	Screen (is grounded at the sensor. The plant must be properly grounded!)	transparent	transparent

2.4.1. Analogue Output 0..10V with a Shunt-Resistor

There are PLC's which have no current inputs 0..20mA, but voltage inputs 0..10V. With the help of a shunt resistor with 500 ohm (in the delivery included) it is possible to generate a 0..10V signal from the current signal 0..20mA. The 500 ohm shunt resistor should be placed at the end of the line resp. at the input of the PLC. Following drawing shows the circuit principle.

Please note: The analogue output of TRIME-GWs must be set to 0 to 20mA!

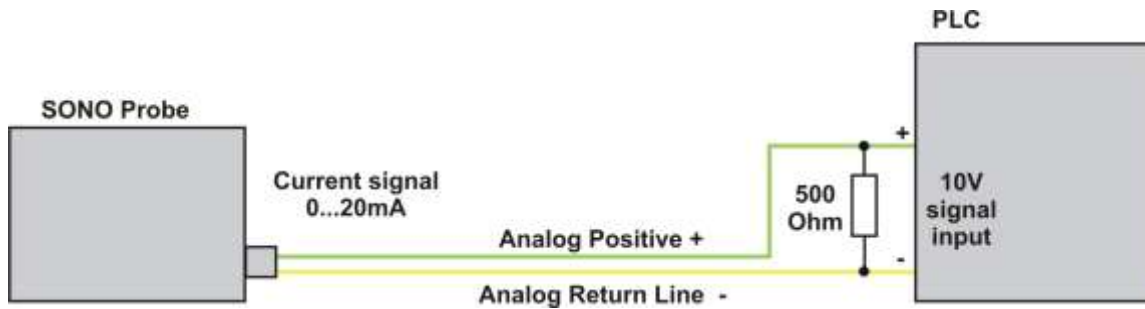

3. Installation in Practice

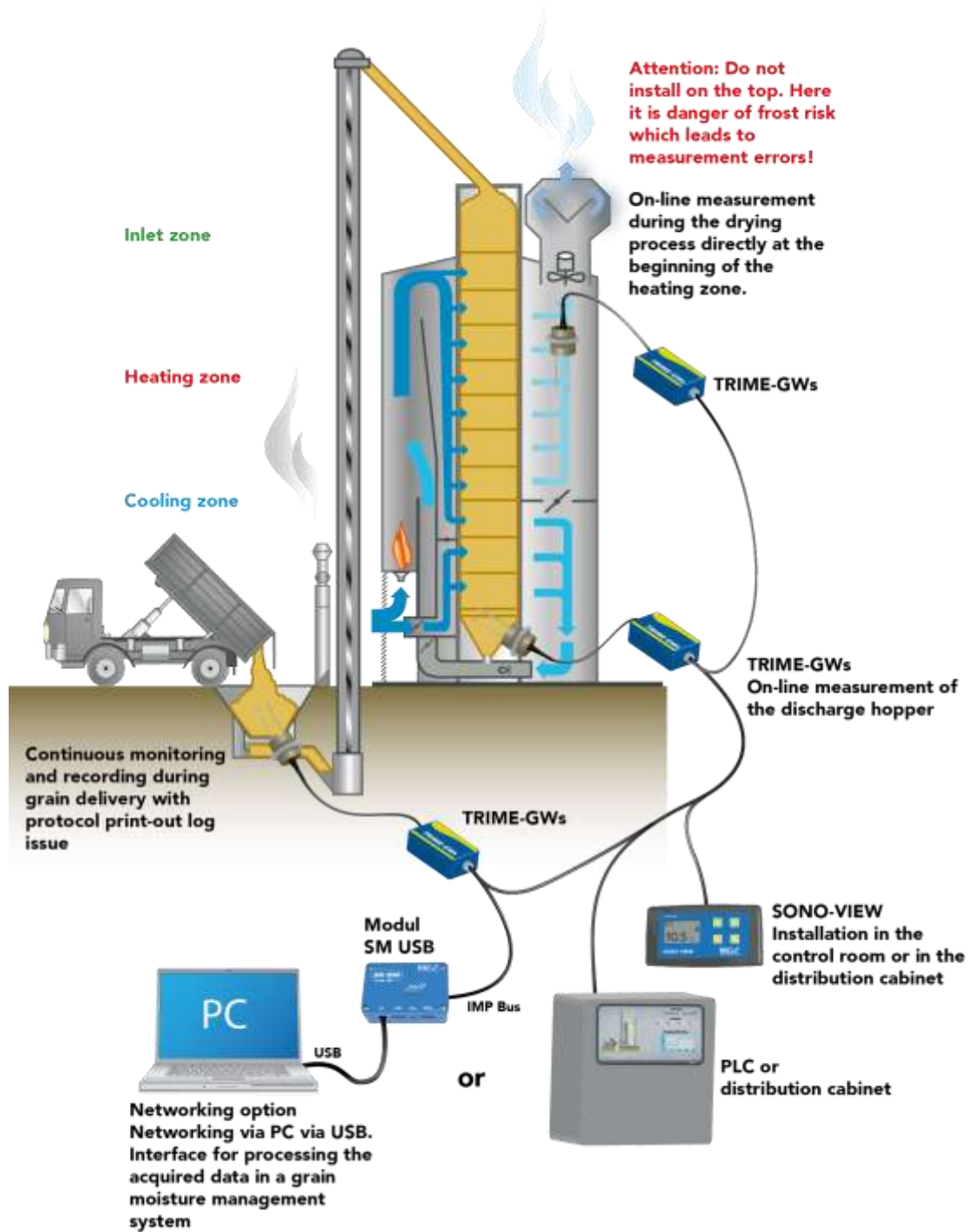

There is a variety of applications for the TRIME-GWs. On the one hand, it can be used for monitoring the moisture of delivered grain. On the other, it can assist or automate the grain-drying process. The conditions for installation depend heavily on the characteristics of the plant. The optimum location must be sought for each case individually. The following guidelines will be of assistance.

3.1.1. Monitoring during grain delivery

The TRIME-GWs offers possibilities of continually measuring the moisture of the grain while it is being delivered. This provides a moisture profile that can be recorded by a PC or a line printer. The display unit SONO-VIEW can be connected as well for showing the values at any given moment. Legal regulations prevent TRIME-GWs being used instead of instruments that have been officially calibrated and authorised for goods traffic. The single measurements, usually based on very small samples, from such instruments are supplemented by the continual, considerably more representative range of measurements taken by the TRIME-GWs. This results in better quality control and enhances transparency.

3.1.2. Manual control of the grain dryer

In the case of manual or semi-automatic dryer-control systems, using the TRIME-GWs in conjunction with the display unit SONO-VIEW can significantly improve drying results.

3.1.3. Automatic control of the grain dryer

This involves connecting the TRIME-GWs to the controller's actual-value input. It is ideal to use several TRIME-GWs in this case. The highest level of drying efficiency can be achieved with automatic control systems.

4. Installation of the GR-Probe

4.1.1. Best installation conditions for TRIME-GWs inside a roof dryer

Near the material feed? Although it is possible to measure the moisture here, the distance to the cooling zone is so far, that a precise control and regulation of moisture with the PLC is not possible. Furthermore it could be possible that grains are frozen, but TRIME-GWs cannot detect frozen water. So an installation here is not recommended.

At the end of the heating zone and transition to the cooling zone? Here it's already too late to react and control the moisture with the PLC. Furthermore the material could have not best homogeneity. So an installation here is also not recommended.

At the beginning of the heating zone: Here the conditions are ideal. The grain is not too hot and the distance to the cooling zone is sufficient for the PLC to regulate for the correct moisture content. With a measured moisture value it is possible to calculate the amount of water reduction.

Depending on grain type like maize, wheat or rye, a suitable calibration curve has to be adjusted inside the TRIME-GWs. At this installation place not the absolute moisture stands in the foreground. Instead it is more important to measure relative moisture values together with an adjusted temperature compensation inside the moisture probe, so that the probe measure precise relative moisture values independent on temperature values. The adjusted calibration curve inside the TRIME-GWs has to be select **with TC** (with Temperature compensation, see chapter "Calibration curves"). Calibration curves with TC use the temperature sensor inside the rod tip of the GR-probe for compensation of temperature changes in the heating zone.

At very large dryer systems it is recommended to use two TRIME-GWs in the heating zone to achieve best possible results.

Inside the cooling zone? An installation **here is not recommended** due to uneven conditions inside the cooling zone.

At the discharge hopper: Here an installation is recommended for controlling the final result after drying and cooling. For displaying correct moisture values it is to taken into account that a suitable calibration curve is to adjust, depending on grain type. A zero offset of TRIME-GWs could be also necessary due to installation place.

If the outfeed is continually and the GR-probe is continually covered with grain, then the calibration curve has to be selected "**with TC**" (Temperature Compensation). However if the outfeed is batch by batch, then the calibration curve has to be selected "**without TC**", because the temperature sensor at the rod tip of the GR probe measures most of the time the air temperature, not the grain temperature, which would lead to measurement failures (see chapter "Calibration Curves").

If only one sensor is installed at the discharge hopper and no sensor in the heating zone, then it is necessary that the feeded wet grain moisture has nearly identical moisture values. In this case a control and regulation with a PLC could be possible. If the feeded grain shows larger deviations then a precise control is impossible with only one TRIME-GWS sensor at the discharge.

4.1.2. Best installation conditions for TRIME-GWs inside a rotary dryer

Recommended is an installation in the funnel, where the material is transported again from bottom to top and where it is secured, that the GR-probe is continually covered with grain.

The GR-probe comprises a cylindrical probe-head made of a heat-resistant special-purpose plastic that has a threaded bore for mounting on silo- or housing walls. The actual measuring probe consists of two parallel, steel prongs that are set into this probe head. The area relevant for moisture measurement surrounds the prongs.

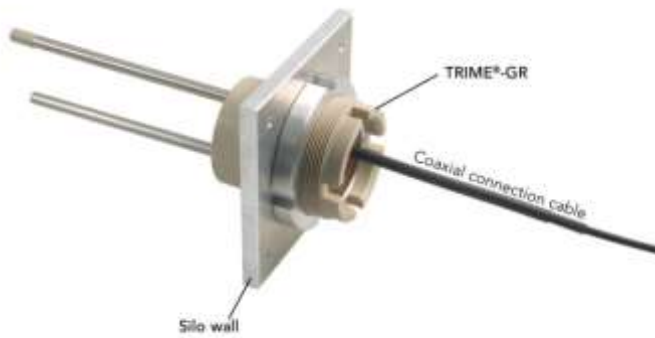

The probe must be fitted in such a way that the prongs protrude into the interior of the dryer or silo. Reliable measurements can only be ensured when the prongs are fully immersed in grain. Therefore, a location for installation must be chosen where ...

- the full length of the prongs is covered by and in contact with grain.
 - hollow spaces cannot occur in the direct vicinity of the probe prongs (at least 5 cm from the prongs).
- the prongs are in the stream of exhaust (outlet) air. The temperature compensation fails in the inlet (heated) air zone.
 - metallic objects, e.g. channelling panels in dryers, are at least 5 cm from the prongs. Measurement anomalies caused by metallic objects can be eliminated by offset-correction (see following schematic diagram).
 - no temperatures above 120°C occur.

4.2. Installation at the exhaust Side of a Roof Drier



In principle an installation directly on the exhaust side of the drier side is possible. **But this installation place has three disadvantages:**

Disadvantage 1: Directly at the drier side there exist other temperature conditions in comparison to the temperatures inside the drier. The measured grain moisture directly at the drier side could be not representative.

Disadvantage 2: Transversely to the GR-rods there could be stick plant particles like tree branches, which leads to difficulties concerning the material flow between the rods. In worst case it could come to a danger of blockage.

Disadvantage3: The GR probe rods in transverse direction to metal surfaces, can influence the measurement.

4.3. Installation directly in the exhaust Air Channel

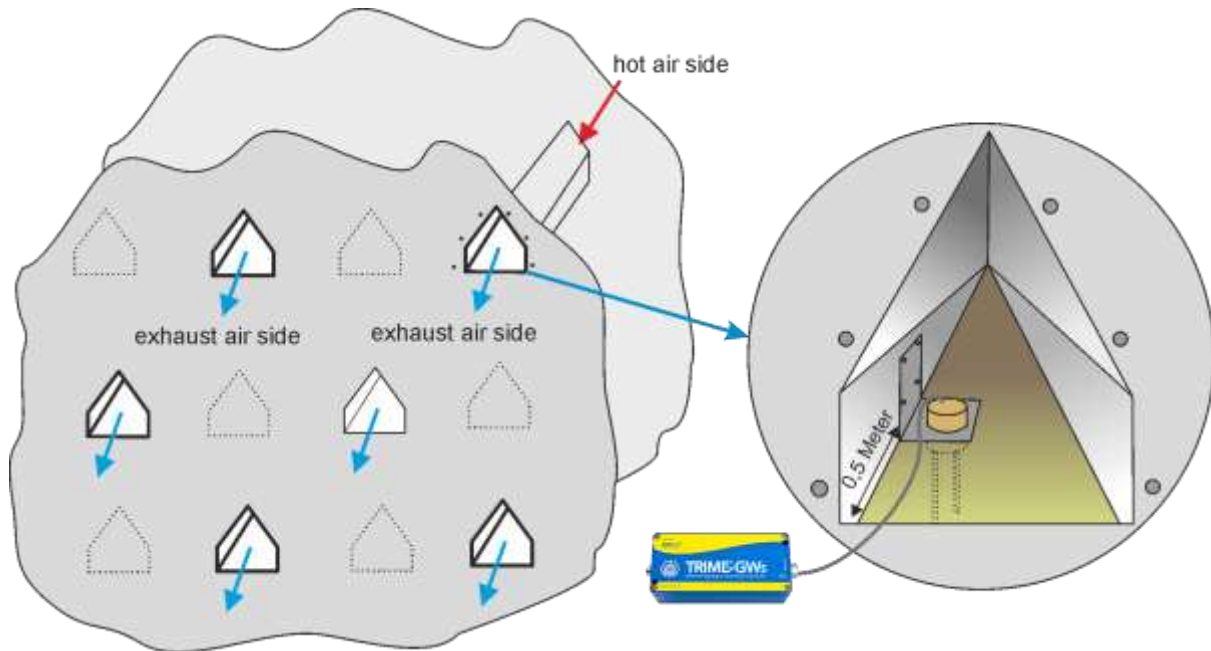

Schematic diagram of a roof drier with installed GR probe.

Installation of the GR probe directly inside the exhaust air channel is of advantage:

Advantage1: With a distance of 0.3 to 0.5 meters from the dryer wall, it is ensured that the grain moisture is measured inside the dryer.

Advantage2: No plant residues can be caught on the rods of the GR probe pointing vertically downwards.

Advantage3: Furthermore, a flow of material flow directly under the exhaust air channel has a positive effect.

IMKO provides a suitable mounting bracket for this installation site

4.4. Installation in Rotary Drier

In **rotary drier**, the GR-probe should be installed at places, where the grain has the lowest flow velocity, because a too high velocity can lead to turbulences around the rods of the GR probe. A good installation place could be e.g. in the storage tank or near the discharge where the circulating grain is once again conveyed upwards and the GR probe is permanently covered with grain.

In the case of **rotary dryers** and hatch points, the probe should be fitted where the grain conveying speed is lowest. We recommend installation in the reservoir or close to the discharge point.

Probe installation can be carried out in the following steps:

1. Drill a 72 mm – diameter hole in the container wall or cut out a square hole using an angle-grinder.
2. Secure the aluminium flange to the wall with four M5 screws (Cut M5 threads into the wall).
3. Screw the probe into the flange as far as possible.
4. Use the locknut to secure the probe in such a way that the prongs are set slight past vertical (10° to 15°).

4.5. Exchange of a GR-Probe

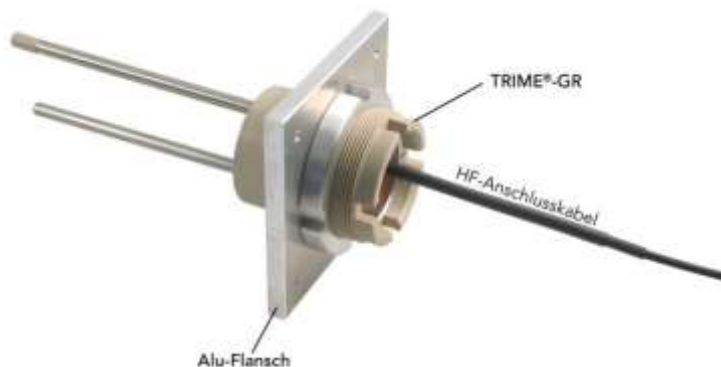

Please note: GR-probes and TRIME-GWs measurement transformers must not be exchanged amongst each other. Please note the serial number, the GR-probe and the TRIME-GWs measurement transformer **must have** the same serial number!

In the event of a mechanical defect it could be necessary to exchange the GR-probe. After connecting a new GR-probe, it is necessary to make a basic balancing with the new GR-probe in air (see chapter "Basic balancing..."). This basic balancing can be made via the module SM-USB and the software tool SONO-CONFIG or directly online via the module SONO-VIEW.

Important: *Under no circumstances the probe should be connected to the instrument while being installed, as the electronics may be destroyed otherwise!*

Attention! Risk of Overvoltage!

In case of welding work at the plant, all probes must be completely electrically disconnected.

SONO-probes need a stabilized power supply with 12V-DC to max. 24 V-DC. With unstabilized power supply there is the risk of overvoltage. We strongly suggest not to use unstabilized power supplies.

Attention! Risk of Malfunction!

1. In larger plants it could be possible, that there are different mass potentials for different power lines in use, especially if the PLC is installed in larger distances to the moisture probe. Here it could come to problems that the analogue moisture signal 0(4)..20mA could not be measured correctly in the PLC. With such a problem we recommend to use an isolated powerbox for the TRIME probe. Available upon request by IMKO.
2. Take care that there are no other electromagnetic fields nearby the TRIME probe. E.g. another moisture probe installed beside or in opposite of the TRIME probe could influence the measurement field.

Any damage caused by faulty installation is not covered by the warranty!

Abrasive wear of sensor parts is not covered by the warranty!

4.6. Installation of the Measurement Transformer TRIME-GWs

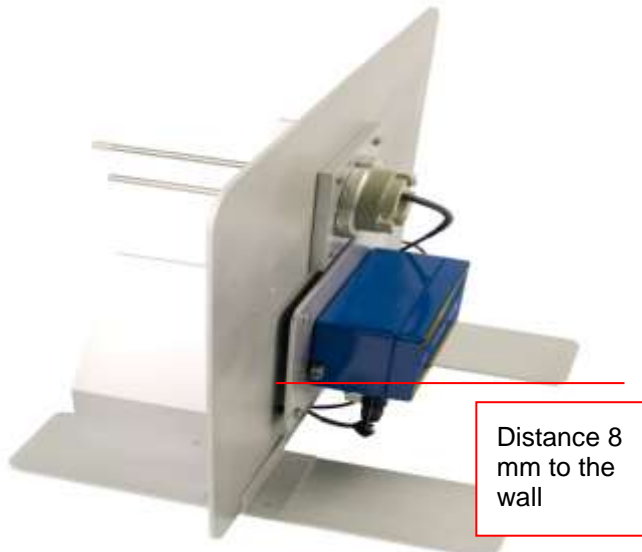

Distance 8 mm to the wall

The TRIME-GWs must be installed in the vicinity of the probe as the length of the probe cable is only 2.5 m for technical reasons. The temperature of the surroundings should, however, not exceed 80°C (ideal: outgoing-air end, external wall of dryer). The instrument can be mounted at a suitable point with screws through the two diagonally-opposed holes in the casing. An aluminium mounting-plate is available as an optional extra. If the instrument is to be mounted on a surface whose temperature exceeds 80°C, it must be fitted using spacing bolts (min. 8 mm) to prevent the direct transfer of heat from the wall to the instrument casing. The instrument should not permanently be exposed to direct precipitation, although it is specified to IP65. For outdoor usage it

should be mounted below a protection roof, e. g. a horizontal mounted plate.

4.7. Protection of the Probe's MIL-Connector against Abrasion

If water could flow above the probe's connector, than it is recommended to mount an extra protection for the probe's connector. This is feasible e.g. with a commercial flexible garden hose with an inner diameter of 27mm. The hose can be slotted longitudinally and can be mounted around the connector and the cable. It could be fixed with cable ties. The following picture shows this solution for protection of the probe's connector.

Alternatively, the included shrink sleeve over the cable can be used. After installation of the SONO-probe and connection of the MIL-connector, the shrink sleeve can be shrunk with a hot air blower.



The picture shows the probe SONO-VARIO



5. Initial Operation and Installation

5.1. Adjustment Guidelines for relative Moisture Measurements in the heating Zone

Please read the detailed description first and subsequently use these guidelines as a checklist for adjustments.

1. **Extract samples from as close as possible to the probe.**
2. **Select calibration curve with help of SONO-VIEW or via the module SM-USB.**
Note: TRIME-GWs is initially adjusted for the application for grain drying with the calibration curve Cal2. The analogue outputs are adjusted to 4..20mA. With this pre-adjustment TRIME-GWs can be installed direct in the heating zone, without further adjustments. For operation at the discharge hopper where an absolute moisture value is important, TRIME-GWs has to be adjusted to a suitable calibration curve Cal-x, depending on grain type and possibly to a zero-offset, depending on installation place.
3. **Start up the dryer for the trial run, extract reference samples continuously approx. every half hour and enter the reading together with the switch position in the adjustment protocol.**
4. **Determine the difference between the target and the actual value and if necessary adjust the offset of the selected calibration curve.**
5. **Repeat this procedure for different grain types.**

5.2. Adjustments for initial Operation

The term “adjustment” refers, in this case, to the correct setting of the calibration curve and zero offset depending on grain type and installation place where an absolute moisture value with an accuracy of $\pm 0,3\%$ is important.

The TRIME-GWs can only be adjusted when installed in the plant as the location and the bulk density of the grain have a significant influence on moisture measurement. Adjustment must be carried out separately for every dried product. Moisture measurement is dependent on the following parameters:

- **Location (e.g. metallic objects within the field of measurement)**
- **Bulk density of the grain**
- **Type of grain (product)**

As soon as one of these parameters changes, another calibration curve and adjustment must be chosen. If all possible grain types are adjusted, it is only necessary to select the right calibration curve when changing the grain type in the plant.

5.2.1. Adjustment for plants with several TRIME-GWs

When the plant is only equipped with one TRIME-GWs, adjustments are made for the installation-related influences at the same time as those for the grain product. Exactly the same procedure can be followed as described in the next sections.

In plants with several probes, it may also be necessary to correct the deviations between the TRIME-GWs themselves. This is good policy only when all the TRIME-GWs are to give an absolute measurement. If the installation-related constant deviation of $\pm 1-2\%$ presents no problem, it is sufficient to make an adjustment using the final control probe, e.g. the TRIME-GWs at the discharge point.

To carry out the extended adjustment for all TRIME-GWs, three steps must be taken:

1. Firstly, the TRIME-GWs which is most important for the drying operation must be selected via the SONO-VIEW or via the module SM-USB. The probe at the discharge point, for example, is a potential candidate. Whichever one TRIME-GWs is chosen, it must be possible to extract samples directly at the point where this probe is located.
2. This TRIME-GWs must be adjusted. Simultaneously, the measurement data for all the other instruments must be gathered, too. The samples for this should be extracted from as near to the probe as possible.
3. Using the differences between the readings of each of the instruments, the TRIME-GWs can be adjusted with help of the SONO-VIEW or via the module SM-USB and a connected PC.

5.2.2. Selection of the calibration curve Cal1 to Cal15

Up to 15 different calibration curves (CAL1 ... Cal15) are stored inside the TRIME-GWs. They can be activated in two ways:

A: With the stand alone module **SONO-VIEW** the calibration curve can be selected and activated.

B: The calibration curve (Cal1. .15) can be activated with the module **SM-USB** which is connected via a PC. In the menu "**Calibration**" and in the window "**Material Property Calibration**" by selecting the desired calibration curve (Cal1...Cal15) and with using the button "**Set Active Calib**". The finally desired and possibly altered calibration curve (Cal1. .15) which is activated after switching on the probes power supply will be adjusted with the button "**Set Default Calib**".

Moisture measurement is dependent on the following parameters:

- **Location (e.g. metallic objects within the field of measurement)**
- **Bulk density of the grain**
- **Type of grain (product)**

The TRIME-GWs can only be adjusted when installed in the plant as the location and the bulk density of the grain have a significant influence on moisture measurement. Adjustment must be carried out separately for every dried product. Moisture measurement is dependent on the following parameters:

- **Location (e.g. metallic objects within the field of measurement)**
- **Bulk density of the grain**
- **Type of grain (product)**

As soon as one of these parameters changes, another calibration curve and adjustment must be chosen. If all possible grain types are adjusted, it is only necessary to select the right calibration curve when changing the grain type in the plant.

5.2.3. Calibration curves with or without temperature compensation

Installation of TRIME-GWs at the beginning of the heating zone: Depending on grain type like maize, wheat or rye, a suitable calibration curve has to be adjusted inside the TRIME-GWs. At this installation place not the absolute moisture stands in the foreground. Instead it is more important to measure relative moisture together with an adjusted temperature compensation for the probe, so that the probe measure precise independent on temperature values. The adjusted calibration curve inside the TRIME-GWs has to be select **with TC** (with Temperature compensation, see chapter "Calibration curves"). Calibration curves with TC use the temperature sensor inside the rod tip of the GR-probe for compensation of temperature changes in the heating zone.

Installation at the discharge hopper: For displaying correct moisture values it is to taken into account that a suitable calibration curve is to adjust, depending on grain type. A zero offset of TRIME-GWs could be also necessary due to installation place.

If the outfeed is continually and the GR-probe is continually covered with grain, then the calibration curve has to be selected "**with TC**" (Temperature Compensation). However if the outfeed is batch by batch, then the calibration curve has to be selected "**without TC**", because the temperature sensor at the rod tip of the GR probe measures most of the time the air temperature, not the grain temperature, which would lead to measurement failures

TRIME-GWs can be easily installed in the heating zone with the pre-setted parameters. It measures moisture values with an accuracy of $\pm 0,3\%$. If TRIME-GWs is installed at the discharge hopper it is necessary to make a precise adjustment for every selected calibration curve.

The following charts (Cal.1 .. Cal15) show different selectable calibration curves which are stored inside the TRIME-GWs.

Plotted is on the y-axis the gravimetric moisture (**MoistAve**) and on the x-axis depending on the calibration curve the associated radar time **tpAve** in picoseconds. With the software **SONO-CONFIG** the radar time **tpAve** is shown on the screen parallel to the moisture value **MoistAve** (see "Quick Guide for the Software SONO-CONFIG).

5.3. Calibration Curves Cal1 to Cal15

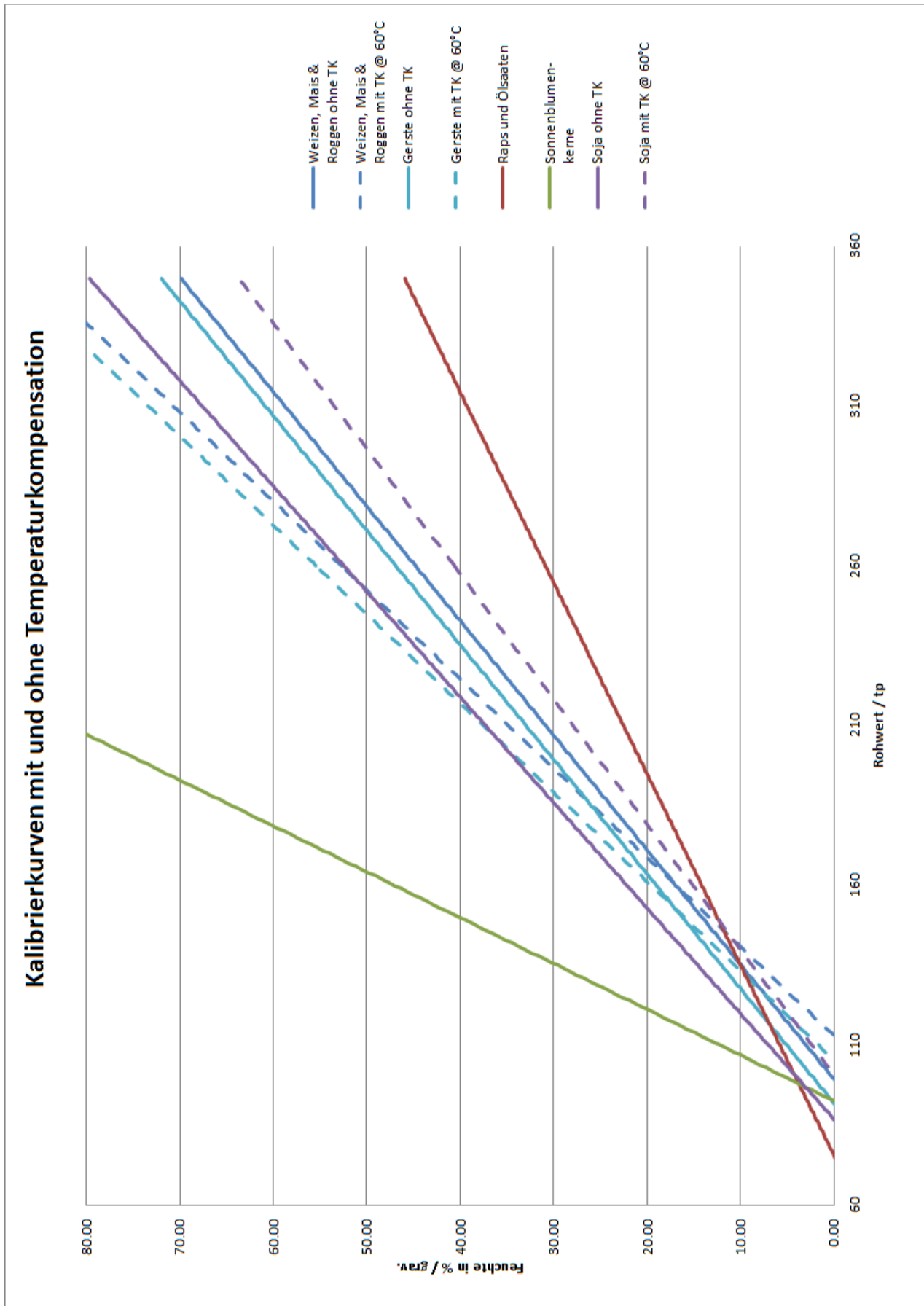

Calibration Curve	Recommended for grain type	Bulk density of grain type	Application
Cal1 (pre-setted after delivery)	Maize, without TC (TC = Temperature Compensation)	0,75	Installation at the discharge hopper. The outfeed is batch by batch and it is not secured, that the GR-probe is continually covered with grain.
Cal2	Maize, with TC	0,75	A: Installation at the beginning of the heating zone, where the GR-probe is continually covered with grain. B: Installation at the discharge hopper if it is guaranteed, that the outfeed is continually and the GR-probe is permanently covered with grain.
Cal3	Wheat without TC	0,75	
Cal4	Wheat with TC	0,75	
Cal5	Rye without TC	0,72	
Cal6	Rye with TC	0,72	
Cal7	Barley without TC	0,63	
Cal8	Barley with TC	0,63	
Cal9	Rape and oilseeds without TC	0.60	No temperature compensation necessary!
Cal10	Sunflower seeds without TC	0,30	No temperature compensation necessary!
Cal11	Soya without TC	0,65	
Cal12	Soya with TC	0,65	
Cal13			
Cal14			
Cal15	1/10 tp		Radar time and reference calibration for test

5.4. Principle of Temperature Compensation

- Temperature compensation is mainly required if the temperature varies more than $\pm 5^{\circ}\text{C}$
- Not all products require a temperature compensation, only products that:
Change their dielectric properties over temperature,
Change their mechanical properties over temperature (torsion that affects the flow or if a product swelling/shrinking)
- In the case of corn and cereals the reason for the compensation mainly is, that if the temperature rises the capillary water of the product will be sweat out and come to the surface, what makes it more "visible" for the sensor
- Thus the affection is more relevant on the dry end of the application (see attached graph), where it can reach more than 1% per 10°C .
- The idea behind the fact, that you can find e.g. the calibration **Wheat** twice (with and without compensation) is, that e.g. in a hopper with a discontinuous discharge you anyhow would need a compensation, but due to the short contact with the material during the discharge every 2..10min. a reliable temperature measurement is not possible and thus it's better to switch of this feature, to not make a bug out of it!
- The compensation can also work if the material and the product temperature is different (what e.g. also is the case in the cooling zone or discharge), as long as the conditions are reliable/repeatable, as the measured temperature would be a mixed temperature that is fine for compensation.

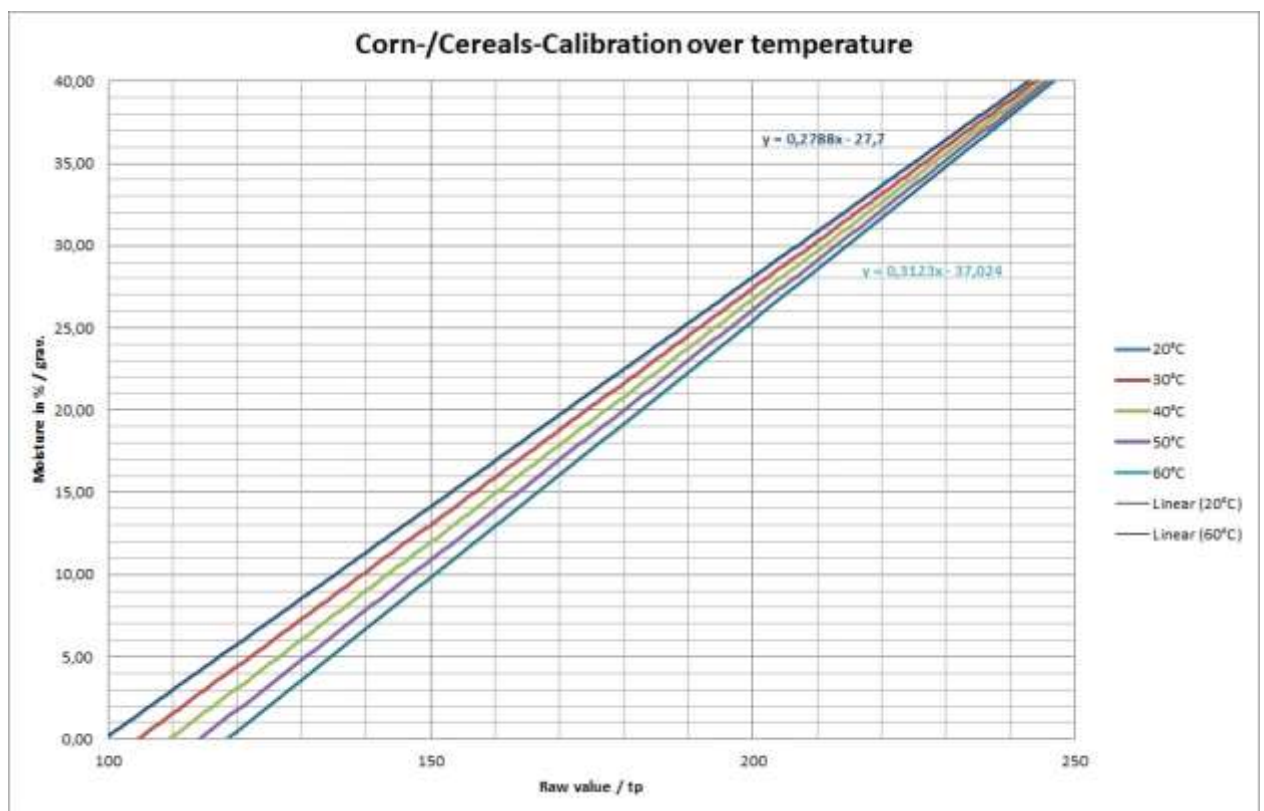

5.5. Selection and application of the reference method

In order to adjust the TRIME-GWs for precise absolute measurements at the discharge, an off-line measurement method must be available to serve as a reference. It must provide a high degree of absolute precision and function with large sample volumes

Most commercially available grain-moisture measuring systems leave a great deal to be desired regarding both of these aspects!

The TRIME-GWs measures the average value continuously over a volume of 1-2 litres. In moving grain, the measurement volume acquired in the averaging time increases many times over. It therefore requires a lot of time and effort to check this very representative value with a reference instrument that shows a sample quantity in the millilitre range. There are also factors that can affect measurement, such as temperature and conductivity, that can be ignored when using TRIME-GWs due to the TDR radar method of measurement.

Thus, the most suitable method for determining the exact moisture of the grain is to use a drying oven. Here, too, the sample volume is of decisive importance and should be at 0.5 litres.

When extracting the sample and taking reference measurements, the following must be observed:

- The samples for the reference measurements should be extracted from as close as possible to the probe. The distribution of moisture in the grain dryer can vary greatly.
- When using a calibrated instrument with small sample volumes, several samples must be extracted and their arithmetical average calculated.
- Please note that calibrated instruments can also produce incorrect measurements that can lie between 2% in the lower and even 5% in the upper moisture range.

After the dryer or the silo has been filled, the TRIME-GWs moisture value must show a valid reading.

5.5.1. Recording measurement data in trial operation

The selection of the calibration curve can only be adjusted in real operation or in realistic trial operation. The following description is based on the implementation of the TRIME-GWs at the discharge, in the delivery or in the storage area.

As a general rule, only the moisture range close to the reference input is of significance for trial operation, i.e. when determining the switch position for maize, checking should be done at about 15%. It is more important that the TRIME-GWs is exactly correct in the lower area of measurement. It is of less importance whether TRIME-GWs measures 26% instead of 28% in the upper range! When extracting a sample or checking the lower reference input (e.g. 15%), a single sample is of course insufficient. A single sample, possibly even extracted from quite a different point than in the direct vicinity of the probe, is not at all representative, i.e. several samples must be taken directly at the probe and averaged!

At the start of trial operation, the suitable calibration curve can be set.

When all the preparations for extracting samples and measuring them have been made, the grain dryer can be started up. Now, a sample of grain must be taken continuously, ideally every 15 minutes. The TRIME-GWs reading **and the selected calibration curve** are to be noted simultaneously with every extracted sample. This is compared with the appropriate offline-determined reference value, which is also to be noted. As soon as the moisture is near the target moisture, the calibration curve should be set to the best possible value, which is the nearest to the reference value.

In the following you will find a ready-to-use form for entering the measurements.

- Where **continuous-flow dryers** are concerned, at least 10 to 20 measurements should be available in the range between the minimum and maximum permissible moisture content after drying. The measurements from the still very damp discharged grain during the charge phase should be noted but not used for the purposes of adjustment.

- For **rotary dryers**, only the measurements take towards the end of the drying process are of relevance to adjustment. Here, too, at least 10 measurements are to have been documented. Density and moisture distribution effects in the grain can cause too low measurements during the first one to two hours. These values should not be used for the adjustment.

5.5.2. Setting the calibration curve (adjustment)

The appropriate setting of the calibration curve should be determined on the adjustment protocol. Only the measurements near the target moisture should be taken into account.

5.5.3. An example for wheat

Note: TRIME-GWs is pre-installed to calibration curve Cal1 for maize.

A continuous-flow dryer is to be set for wheat. A TRIME-GWs has been installed whose probe is located in the direct vicinity of the discharge point. To start with, the calibration curve is set to Cal.... for wheat. The dryer is started up and measurement recording commences. It is not until the moisture at the discharge point falls below 18% that the measurements become of real interest and can be used for the adjustment process. Analysis can start as soon as about 10 to 20 measurements are available in the range from 12% to 18%.

Reference measurement	TRIME-GW, Level 1	TRIME-GW deviation
17.9%	24.6%	1
17.3%	17.6%	8
17.8%	17.3%	8
17.1%	16.8%	8
16.8%	16.2%	8
16.5%	15.8%	8
15.8%	16.0%	7
15.1%	15.6%	7
14.5%	14.7%	7
13.9%	14.0%	7
13.3%	13.5%	7

5.6. Creating a linear Calibration Curve for a specific Material

The calibration curves Cal1 to Cal15 can be easily created or adapted for specific materials with help of SONO-CONFIG. Therefore, two measurement points need to be identified with the probe. **Point P1 at dried material** and **point P2 at moist material** where the points P1 and P2 should be far enough apart to get a best possible calibration curve. The moisture content of the material at point P1 and P2 can be determined with laboratory measurement methods (oven drying). It is to consider that sufficient material is measured to get a representative value.

Under the menu "**Calibration**" and the window "**Material Property Calibration**" the calibration curves CAL1 to Cal15 which are stored in the SONO probe are loaded and displayed on the screen (takes max. 1 minute). With the mouse pointer individual calibration curves can be tested with the SONO-probe by activating the button "**Set Active Calib**". The measurement of the moisture value (**MoistAve**) with the associated radar time **tpAve** at point P1 and P2 is started using the program SONO-CONFIG in the sub menu "**Test**" and "**Test in Mode CF**" (see "Quick Guide for the Software SONO- CONFIG").

Step 1: The radar pulse time **tpAve** of the probe is measured with dried material. Ideally, this takes place during operation of a mixer/dryer in order to take into account possible density fluctuations of the material. It is recommended to detect multiple measurement values for finding a best average value for **tpAve**. The result is the first calibration point P1 (e.g. 70/0). I.e. 70ps (picoseconds) of the radar pulse time **tpAve** corresponds to 0% moisture content of the material. But it would be also possible to use a higher point P1' (e.g. 190/7) where a **tpAve** of 190ps corresponds to a moisture content of 7%. The gravimetric moisture content of the material, e.g. 7% has to be determined with laboratory measurement methods (oven drying).

Step 2: The radar pulse time **tpAve** of the probe is measured with moist material. Ideally, this also takes place during operation of a mixer/dryer. Again, it is recommended to detect multiple measurement values of **tpAve** for finding a best average value. The result is the second calibration point P2 with X2/Y2 (e.g. 500/25). I.e. **tpAve** of 500ps corresponds to 25% moisture content. The gravimetric moisture content of the material, e.g. 25% has to be determined with laboratory measurement methods (oven drying).

Step 3: With the two calibration points P1 and P2, the calibration coefficients m_0 and m_1 can be determined for the specific material (see next page).

Step 4: The coefficients $m_1 = 0.0581$ and $m_0 = -4.05$ (see next page) for the calibration curve Cal14 can be entered directly by hand and are stored in the probe by pressing the button "**Set**". The name of the calibration curve can also be entered by hand. The selected calibration curve (e.g. Cal14) which is activated after switching on the probes power supply will be adjusted with the button "**Set Default Calib**".



Attention: Use "dot" as separator (0.0581) in SONO-CONFIG, not comma !

5.6.1. Calculation for a linear 2-point calibration curve

1. Download the Excel-Sheet „**SONO 2-Point LinearCalibration_Calculation**“ from IMKO's Homepage under „Support Software“.
2. Enter into the Excel-Sheet both TP-values with the respective reference moisture values.
3. Read out both parameters m_0 and m_1 from the Excel-Sheet.
4. Enter, set and save both parameters m_0 and m_1 with help of the software „SONO-CONFIG“ in the menu „**Calibration**“ in the window „**Material Property Calibration**“ in the selected calibration curve.

5.6.2. Calculation for a linear 1-point calibration curve

In practice during commissioning of a SONO probe in process, it could be happen that the measured material above the probe is only available with a single moisture value. So a 2-point calibration could not be carried out.

The procedure described below is not as precisely like a 2-point calibration, but it could be a compromise to achieve an acceptable result for a usable calibration curve.

Below you will find the basic steps which are necessary:

1. Measure the radar travel time **Tp** in the running process while the material lies or flows above the SONO probe's surface. **Tp** can be measured with help of the module **SM-USB** or with the display module **SONO-VIEW**.
2. Determine the reference moisture **M in %** of the measured material which lies above the SONO probe. Unless the material moisture is already known, the reference moisture can be determined with an infrared- or microwave oven in the laboratory.
3. Determine the bulk **density D** of the material in kg per dm³. Unless the bulk density is already known this can be done by weighing of exactly 1 liter volume of the material.
4. Download the Excel-Sheet „**SONO 1-Point LinearCalibration_Calculation**“ from IMKO's Homepage under „Support Software“. Enter the three determined parameters **Tp** (Radar travel time), **M** (Moisture) und **D** (bulk density) into the Excel-Sheet. As result you get the two calibration curve coefficients m0 and m1.
5. Enter, set and save both parameters m0 and m1 with help of the software „SONO-CONFIG“ in the menu „**Calibration**“ in the window „**Material Property Calibration**“ in the selected calibration curve. The three parameters **Tp**, **M** and **D** can be also entered without a PC with the module SONO-VIEW (see manual SONO-VIEW).

5.6.3. Calculation for a non-linear calibration curve

SONO probes can work also with non-linear calibration curves with polynomials up to 5th grade. For a non-linear calibration it is necessary to calibrate with 4...8 different calibration points with different Tp values and the related moisture values in %. To calculate nonlinear coefficients for polynomials up to 5th grade, an EXCEL software tool from IMKO can be used.

1. Download the Excel-Sheet „**SONO_NonlinearCalibration_Calculation**“ from IMKO's Homepage under „Support Software“.
2. Enter the TP-values with the respective reference moisture values into the Excel-Sheet.
3. Read out the parameters m0 to m5 from the Excel-Sheet.
4. Enter, set and save the parameters m0 to m5 in the selected calibration curve with help of the software „SONO-CONFIG“ in the menu „**Calibration**“ under the window „**Material Property Calibration**“.

5.7. Configuration of the Measure Mode

TRIME-GWs is pre-adjusted in the factory before delivery to mode CF. A process-related later new adjustment of this device-internal setting is possible with the help of the service program **SONO-CONFIG** or **directly online with SONO-VIEW**. For all activities regarding parameter setting and calibration the probe can be directly connected via the RS485 interface to the PC via a RS485 USB-Module which is available from IMKO.

The following settings of TRIME-GWs can be amended with the service program **SONO-CONFIG**:

Measurement-Mode and Parameters:

- Measurement Mode A-On-Request (only in network operation for the retrieval of measurement values via the RS485 interface).
- Measurement Mode C Cyclic:

TRIME-GWs is supplied ex factory with suited parameters in Mode CF with 3 second average time for bulk goods.

Mode CS: (Cyclic-Successive) For very short measuring processes (e.g. 5...20 seconds) without floating average, with internal up to 100 measurements per second and a cycle time of 250 milliseconds at the analogue output. Measurement mode CS can also be used for getting raw data from the TRIME-GWs without averaging and filtering.

Mode CA: (Cyclic-Average-Filter) For relative short measuring processes with continual average value, filtering and an accuracy of up to 0.1%

Mode CF: (Cyclic-Float-Average) for continual average value with filtering and an accuracy of up to 0.1% for very slowly measuring processes, e.g. in fluidized bed dryers, conveyor belts, etc.

Mode CK: (Cyclic-Kalman-Filter) Standard setting for SONO-MIX for use in fresh concrete mixer with continual average value with special dynamic Kalman filtering and an accuracy of up to 0.1%.

Mode CC: (Cyclic Cumulated) with automatic summation of a moisture quantity during one batch process.

- Precision of a single TDR radar pulse measurement (see in chapter „Software tool SONO-CONFIG“ under point „Setting the precision of a single value measurement“).
- Calibration (if completely different materials are deployed)

Each of these settings will be preserved after shut down of the probe and is therefore stored on a permanent basis.

5.7.1. Operation Mode CA and CF at non-continuous Material Flow

For mode CA and CF the TRIME-GWs is supplied ex-factory with suited parameters for the averaging time.

The setting options and special functions of TRIME-GWs depicted in this chapter are only rarely required. It is necessary to take into consideration that the modification of the settings or the realisation of these special functions may lead to faulty operation of the probe!

For applications with non-continuous material flow, there is the option to optimise the control of the measurement process via the adjustable filter values *Filter-Lower-Limit*, *Filter-Upper-Limit* and the time constant *No-Material-Keep-Time*. The continual/floating averaging can be set with the parameter *Average-Time*.

Parameters in the Measurement Mode CA, CF, CC, CH and CK	Function
<p>Average-Time Standard Setting: 2s Setting Range: 1...20 Unit: Seconds</p>	<p>CA/CF: Time (in seconds) for the generation of the average value can be set with this parameter. CC/CH/CK: Setting of the time for calculation of the trend or expectation value for the Boost & Offset function.</p>
<p>Filter-Upper-Limit-Offset Standard Setting: 25% Setting Range: 1...20 Unit: % Absolut</p>	<p>CA/CC/CF/CH/CK: Too high measurement values generated due to metal wipers or blades are filtered out. The offset value in % is added to the dynamically calculated upper limit.</p>
<p>Filter-Lower-Limit-Offset Standard Setting: 25% Setting Range: 1...20! Unit: % Absolut</p>	<p>CA/CC/CF/CH/CK: Too low measurement values generated due to insufficient material at the probe head are filtered out. The offset value in % is subtracted from the dynamically calculated lower limit with the negative sign.</p>
<p>Upper-Limit-Keep-Time Standard Setting: 10 Setting Range: 1...100 Unit: % Absolut</p>	<p>CA/CC/CF/CH/CK: The maximum duration (in seconds) of the filter function for Upper-Limit-failures (too high measurement values) can be set with this parameter.</p>
<p>Lower-Limit-Keep-Time Standard Setting: 10 Setting Range: 1...100s Unit: Seconds</p>	<p>CA/CC/CF/CH/CK: The maximum duration (in seconds) of the filter function for Lower-Limit-failures (too low measurement values) for longer-lasting "material gaps", ie the time where no material is located on the probe's surface can be bridged.</p>
<p>Moisture Threshold (start threshold in %-moisture) Standard Setting: 0.1% Setting Range: 0... 100% Unit: % Absolut</p>	<p>CA/CF/CK: inactive CC/CH: The accumulation of moisture values starts above the „Moisture Threshold“ and from here the analogue signal is outputted. The accumulation pauses and will be frozen if the moisture level is below the threshold value. The No-Material-Delay time starts and material gaps (disturbance) can be eliminated.</p>
<p>No-Material-Delay (period time) Standard Setting: 10s Setting Range: 1... 100s Unit: Seconds</p>	<p>CA/CF/CK: inactive CC/CH: The accumulation stops if the moisture value is below the Moisture Threshold. The accumulation pauses for the period of the setted delay time and will be frozen if the moisture level is below the threshold value. The SONO probes starts again in a new batch with a new accumulation after the setted time span of the "No-Material-Delay" is completely exceeded.</p>
<p>Boost Standard Setting: 35nn Setting Range: 1... 100nn Unit: without unit!</p>	<p>CA/CF: inactive CC/CH/CK: Defines, how strong single measurement values are weighted dependent on deviation to the current expected average value. With e.g. Boost=35, a single measurement value is weighted with only 65% (100-35) for a new average value.</p>
<p>Offset Standard Setting: 0.5% Setting Range: 0 ...5% Unit: % Absolut</p>	<p>CA/CF: inactive CC/CH/CK: Non-linearities in the process can be compensated by higher weighting of higher values. Can be used e.g. in fluid bed dryers or under silo flaps where non-linearities can occur due to changes in the material density during process. "Offset" works together with the parameter "Average-time".</p>
<p>Weight Standard Setting: 5 values Setting Range: 050 Unit: Measurement Values</p>	<p>CA/CF/CK: inactive CH: Smoothing factor for analog output setting. This parameter influences the reaction/response time with factor 3. E.g. 15 values responds to a reaction time of 15/3=5 seconds. CK: The reaction/response time works nearly 1:1. E.g. 15 values responds to a reaction time of 15 seconds.</p>

<p>Invalid Measure Count Standard Setting: 2 values Setting Range: 0..... 10 Unit: Measurement Values with 3 single values per second.</p>	<p>CA/CF/CK: inactive CC/CH: Number of discarded (poor) measurement values after the start of a new batch, when „No-Material-Delay“ has triggered. The first measurement values will be rejected, e.g. due to dripping water.</p>
<p>Moisture Std. Deviation Count Standard Setting: 5 values Setting Range: 0..... 20 Unit: Measurement Values with 3 single values per second.</p>	<p>CA/CC/CF/CH/CK: If the parameters Temperature or EC-TRIME (RbC) are not needed, the analogue output 2 can be set to the mode Moist/Moist Std. Deviation. In this mode the standard deviation of all single moisture values can be outputted. With this function the homogeneity of the single measurement values can be determined and it is possible to control a regulating process, e.g. pressure regulation.</p>
<p>Quick und Quick-Precision With Meas Time (no. values) Unit: without unit!</p>	<p>CA/CC/CF/CH/CK/CS: Recommended is Quick Precision with Meas Time=2 where the TDR pulse is detected precisely. For still a little better accuracies, Meas Time can be increased, however the single measurement cycle is increased by 60 milliseconds per step (e.g. from 280ms to 340ms). Older SONO probe versions do not have this Quick Precision function!</p>

5.7.2. Average Time in the measurement mode CA and CF

TRIME-GWs establishes every 200 milliseconds a new single measurement value which is incorporated into the continual averaging and issues the respective average value in this timing cycle at the analogue output. The averaging time therefore accords to the “memory” of the TRIME-GWs. The longer this time is selected, the more inert is the reaction rate, if differently moist material passes the probe. A longer averaging time results in a more stable measurement value. This should in particular be taken into consideration, if the TRIME-GWs is deployed in different applications in order to compensate measurement value variations due to differently moist materials.

At the point of time of delivery, the *Average Time* is set to 4 seconds. This value has proven itself to be useful for many types of applications. At applications which require a faster reaction rate, a smaller value can be set. Should the display be too “unstable”, it is recommended to select a higher value.

5.7.3. Filtering at material gaps in mode CA and CF

A TRIME-GWs is able to identify, if temporarily no or less material is at the probe head and can filter out such inaccurate measurement values (**Filter-Lower-Limit**). Particular attention should be directed at those time periods in which the measurement area of the probe is only partially filled with material for a longer time, i.e. the material (sand) temporarily no longer completely covers the probe head. During these periods (**Lower-Limit-Keep-Time**), the probe would establish a value that is too low. The **Lower-Limit-Keep-Time** sets the maximum possible time where the probe could determine inaccurate (too low) measurement values.

Furthermore, the passing or wiping of the probe head with metal blades or wipers can lead to the establishment of too high measurement values (**Filter-Upper-Limit**). The **Upper-Limit-Keep-Time** sets the maximum possible time where the probe would determine inaccurate (too high) measurement values.

Using a complex algorithm, TRIME- GWs are able to filter out such faulty individual measurement values. The standard settings in the **Measurement Mode CA and CF** for the filter functions depicted in the following have proven themselves to be useful for many applications and should only be altered for special applications.

It is appropriate to bridge material gaps in mode CA with Upper- and Lower-Limit Offsets and Keep-Time. For example the Lower-Limit Offset could be adjusted with 2% with a Lower-Limit Keep-Time of 5 seconds. If the TRIME-GWs determines a moisture value which is 2% below the average moisture value with e.g. 8%, than the average moisture value will be frozen at this value during the Lower-Limit Keep-Time of 5 seconds. In this way the material gap can be bridged. This powerful function inside the TRIME-GWs works here as a highpass filter where the higher moisture values are used for building an average value, and the lower or zero values are filtered out. In the following this function is described with SONO parameters.

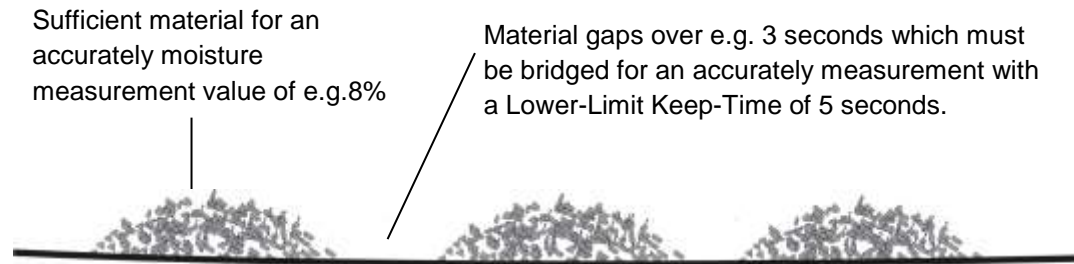

The following parameter setting in mode CA fits a high pass filtering for bridging material gaps.

Average Mode under Mode C	
CA-Cyclic Average	
Average Parameters:	
Average Time(s)	1
Filter Upper Limit Offset	20
Filter Lower Limit Offset	2
Upper Limit Keep Time	10
Lower Limit Keep Time	5

The Filter Upper-Limit is here deactivated with a value of 20, the Filter Lower-Limit is set to 2%. With a Lower-Limit Keep-Time of 5 seconds the average value will be frozen for 5 seconds if a single measurement value is below the limit of 2% of the average value. After 5 seconds the average value is deleted and a new average value building starts. The Keep-Time function stops if a single measurement value lies within the Limit values.

5.7.4. Mode CC – automatic summation of a moisture quantity during one batch process

Simple PLCs are often unable to record moisture measurement values during one batch process with averaging and data storage. Furthermore there are applications without a PLC, where accumulated moisture values of one batch process should be displayed to the operating staff for a longer time. Previously available microwave moisture probes on the market show three disadvantages:

1. Such microwave probes need a switching signal from a PLC for starting the averaging of the probe. This increases the cabling effort.
2. Time delays can occur during the summation time with a trigger signal which leads to measurement errors. This is particularly disadvantageous for small batches, recipe errors can occur.
3. Material gaps during one batch process will lead to zero measurement values which falsify the accumulated measurement value considerably, recipe errors can occur.

Unlike current microwave probes, TRIME-GWs work in mode CC with automatic summation, where it is really ensured that material has contact with the probe. This increases the reliability for the moisture measurement during one complete batch process. The summation is only working if material fits at the probe. Due to precise moisture measurement also in the lower moisture range, TRIME-GWs can record, accumulate and store moisture values during a complete batch process without an external switching or trigger signal. The TRIME-GWs “freezes” the analogue signal as long as a new batch process starts. So the PLC has time enough to read in the “frozen” moisture value of the batch. For applications without a PLC the “frozen” signal of the TRIME-GWs can be used for displaying the moisture value to a simple 7-segment unit as long as a new batch process starts.

With the parameter **Moisture Threshold** the TRIME-GWs can be configured to the start moisture level where the summation starts automatically. Due to an automatic recalibration of TRIME-GWs, it is ensured that the zero point will be precisely controlled. The start level could be variably set dependent to the plant. Recommended is a level with e.g. 0.5% to 1%.

With the parameter **No-Material-Delay** a time range can be set, where the TRIME-GWs is again ready to start a new batch process. Are there short material gaps during a batch process which are shorter than the “No-Material-Delay”, with no material at the probes surface, then the TRIME-GWs pauses shortly with the summation. Is the pause greater as the “No-Material-Delay” then the probe is ready to start a new batch process.

How can the mode CC be used, if the TRIME-GWs cannot detect the „moisture threshold“ by itself, e.g. if there is constantly material above the probe over a longer time: In this case, a short interrupt of the probe’s power supply, e.g. for about 0.5 seconds with the help of a relay contact of the PLC, can restart the TRIME-GWs at the beginning of the material transport. After this short interrupt the TRIME-GWs starts immediately with the summarizing and averaging.

Please note: It should be noted that no material sticks on the probes surface. Otherwise the moisture zero point of the probe will be shifted up and the probe would not be detect a moisture low value below the “Moisture-Threshold”.

Following possible parameter settings in mode CC inside the TRIME-GWs can be set:

Parameter in mode CC	Function
Moisture Threshold (in %-moisture) Standard Setting: 1 Setting Range: 1....20	The accumulation of moisture values starts above the „Moisture Threshold“ and the analogue signal is output. The accumulation pauses if the moisture level is below the threshold value.
No-Material-Delay (in seconds) Standard Setting: 5 Setting Range: 1....20	The accumulation stops if the moisture value is below the moisture threshold. The TRIME-GWs starts again in a new batch with a new accumulation after the time span of the “No-Material-Delay” is exceeded.

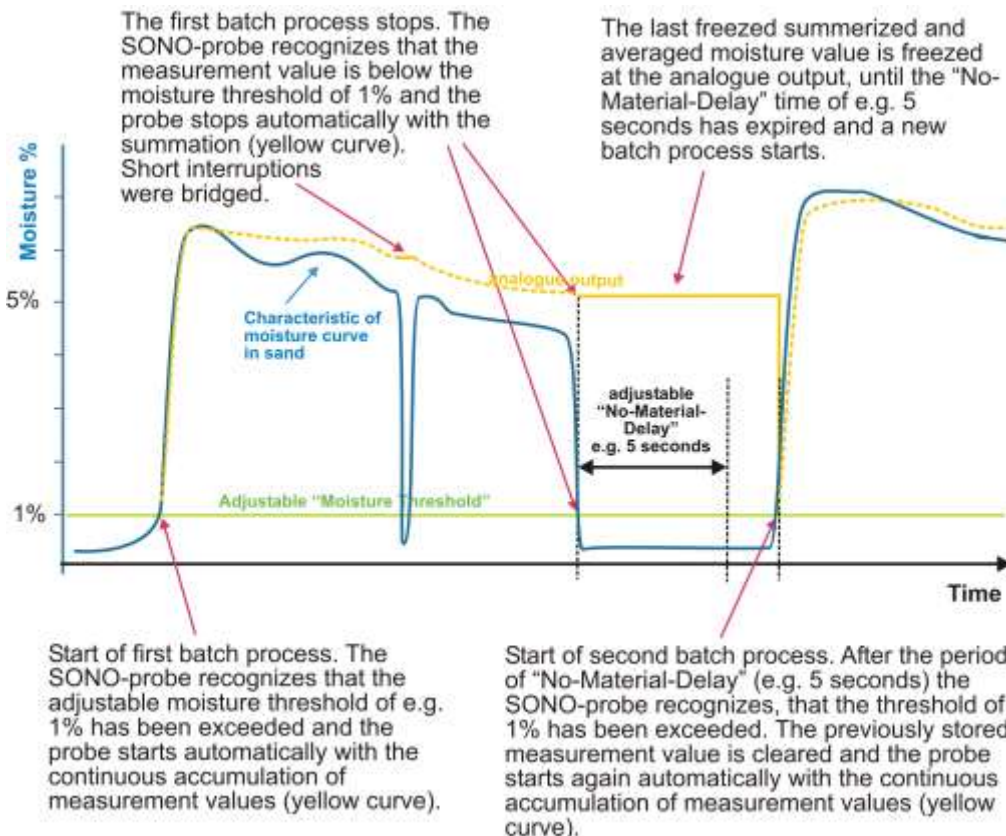

6. Serial Connection to the SM-USB Module from IMKO

The SM-USB provides the ability to connect a SONO probe either to the standard RS485 interface or to the IMP-Bus from IMKO. **In fact that the IMP-Bus is more robust and enables the download of a new firmware to the SONO probe, the SONO probes are presetted ex-factory to the IMP-Bus. So it is recommended to use the IMP-Bus for a serial communication.** Both connector ports are shown in the drawing below.

The SM-USB is signalling the status of power supply and the transmission signals with 4 LED's. When using a dual-USB connector on the PC, it is possible to use the power supply for the SONO probe directly from the USB port of the PC without the use of the external AC adapter.

Connection to the Probe:

RS485 Connector

Pin B: 0V Power Supply
 Pin A: +12VDC Power Supply
 Pin G: RS485B Lead Colour "brown"
 Pin F: RS485A Lead Colour "white"

IMP-Bus Connector

With the option to accomplish a download of the firmware for the SONO probe

Pin B: 0V Power Supply
 Pin A: +12VDC Power Supply
 Pin C: (rt) Lead Colour "grey/pink"
 Pin J: (com) Lead Colour "blue/red"

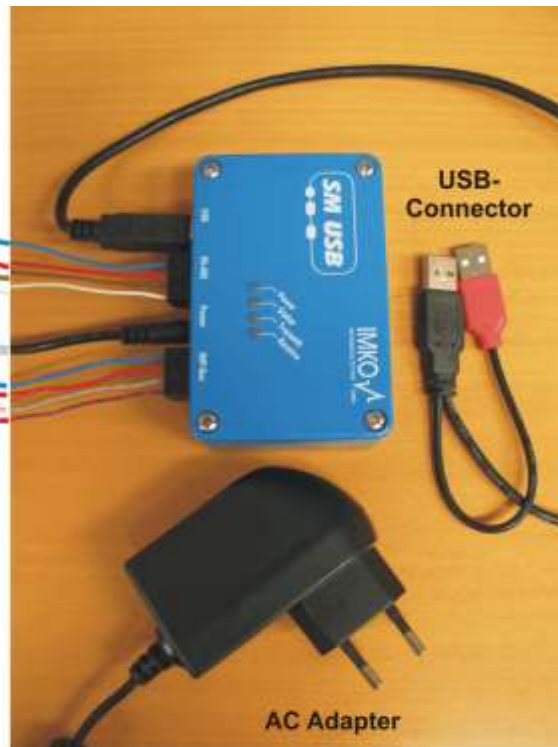

How to start with the SM-USB module from IMKO

- Install USB-Driver from USB-Stick.
- Connect the SM-USB to the USB-Port of the PC and the installation will be accomplished automatically.
- Install Software **SONOConfig-SetUp.msi** from USB-Stick.
- Connection of the SONO probe to the SM-USB, with 4 wires for power supply and serial interface.
- Check the setting of the COM-Ports in the Device-Manager und setup the specific COM-Port with the Baudrate of 9600 Baud in SONO-CONFIG with the button "**Bus**" and "**Configuration**" (COM1-COM15 is possible).
- Start "**Scan probes**" in SONO-CONFIG.
- The SONO probe logs in the window „**Probe List**“ after max. 30 seconds with its serial number.

Note 1:

In the Device-Manager passes it as follows:

Control Panel → System → Hardware → Device-Manager

Under the entry “Ports (COM & LPT) now the item “USB Serial Port (COMx)” is found.

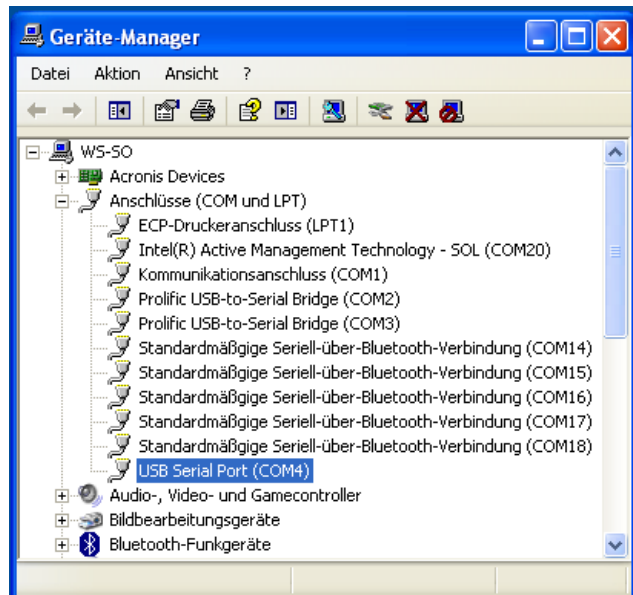

COMx set must be between COM1....COM9 and it should be ensured that there is no double occupancy of the interfaces.

If it comes to conflicts among the serial port or the USB-SM has been found in a higher COM-port, the COM port number can be adjusted manually:

By double clicking on "USB Serial Port" you can go into the properties menu, where you see "connection settings" – with "Advanced" button, the COM port number can be switched to a free number.

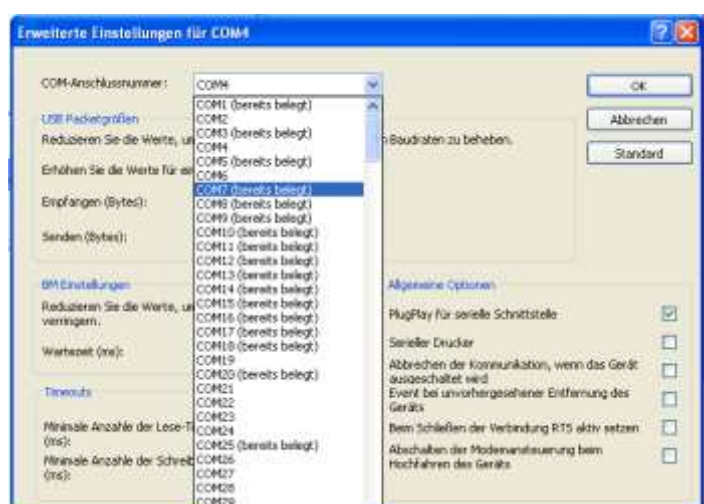

After changing the COMx port settings, SONO-CONFIG must be restarted.

7.1.2. Configuration of serial SONO-interface

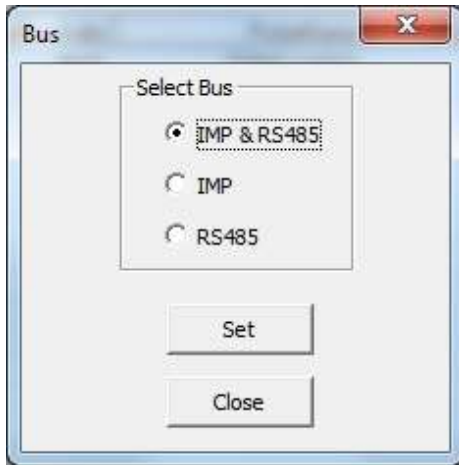

The serial interface inside the SONO probe can be selected to IMP-Bus or RS485. Due to very robust behavior it is recommended to select the IMP-Bus.

7.1.3. Set analogue outputs of the SONO probe

In the menu "Config" and the window "Analog Output" the two analogue outputs of the SONO probe can be configured (see Chapter "Analogue outputs..").

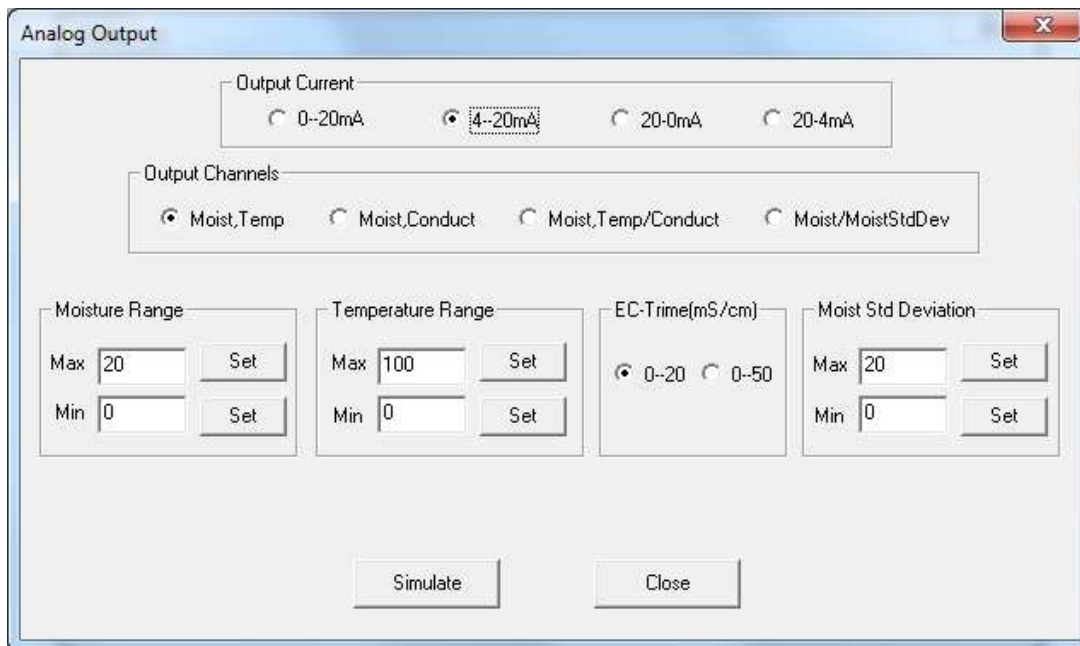

7.1.4. Configuration of Measure Mode

In "Probe List" with "Config" and "Measure Mode & Parameters" the SONO probe can be adjusted to the desired measure mode CA, CF, CS, CK, CC or CH (see Chapter "Configuration Measure Mode

Measure Mode & Parameters

Default Cycle Mode: C Cyclic [Set Default]

Measure Mode & Parameters

Actual Cycle Mode: C Cyclic

Average Mode of Mode C: CA-Cyclic Average

Kalman with Boost: No Yes

Offset with MoistAve/10: No Yes

Average Parameters:

Average Time(s)	5
Filter Upper Limit Offset(%/abs)	25
Filter Lower Limit Offset(%/abs)	25
Upper Limit Keep Time(s)	10
Lower Limit Keep Time(s)	10
Moisture Threshold(%/abs)	1
No Material Delay(s)	10
Boost(nn)	20
Offset(%/abs)	1
Weight(no.values)	5
Invalid Measure Count(no.values)	2
Moist Std Deviation Count(no.values)	0

[Set]

Single Precise Parameters

Quick Quick Precise Mode A Precise

Single MeasNo(no.) 5 PreciseVal(no.) 0 [Set]

[Close]

By selecting the operating mode, the SONO probe can be set up to different measurement modes, e.g. for averaging values from several single measurement values, for performing a filtering or performing other functions (see chapter "Measurement mode configuration" in this manual).

Furthermore, a SONO probe can be set to a special required precision of the single value measurement with "Single Precise Parameters". It is about settings, how the TDR radar pulse is executed and evaluated during one measurement cycle. The next chapter describes how this can be done.

7.1.5. Setting the precision of a single value measurement cycle

The SONO probe can be adjusted to the precision of a single value measurement via "**Single Precise Parameters**". First of all, the more accurate the SONO probe has to measure, the longer the time required for a single value measurement with a TDR radar pulse evaluation. There are applications where the SONO probe under a silo valve has only 2 to 4 seconds to perform several measurements with average value building. Here, a precise single value measurement would take too long, which is why the setting "**Quick**" with a shorter measuring time of 280 ms is recommended. Especially since the fluctuating flow of material under a silo valve cannot lead to constant conditions anyway in order to be able to carry out a highly precise individual measurement.

However, there are applications where it is necessary to achieve measuring accuracies up to + -0.05% moisture content which is only possible with very constant material conditions. E.g. in liquids with fractions of water in oil or in emulsions.

The following table provides an overview of the possible settings in the SONO probe for a single TDR radar pulse evaluation.

Parameter Setting	Measure-Mode	Function of the parameter	Application
Quick:	Mode C e.g. CS, CH, CF, etc.	Very quick TDR pulse search and very quick measurement within 280 ms.	e.g. under a silo flap with only 2-4 seconds measurement time.
Quick Precise:	Mode C e.g. CS, CH, CF, etc.	Quick and precise TDR pulse search and precise measurement within 350ms.	Similar to „Quick“ but with a little longer reaction time in process measurements.
Mode A:	Mode A	Mode A only with measurements via serial interface of the sensor. E.g. for calibrations.	Mode A for mobile moisture probes with hand measurement device HD2 or SONO-DIS.
Precise: PreciseVal: Input value: 1....4	Mode C <u>and</u> Mode A	Most precise single value measurement with precise TDR radar pulse triggering and pulse analysis. The higher the value 1 to 4 the higher the precision but the longer the measurement time.	Only in process environment where a continuously material flow is guaranteed and a very high precision is necessary.
Single MeasNo Default value: 4 Input value max. 10	Mode C <u>and</u> Mode A	Additional averaging of the single value measurement. Please consider: when 10 is entered, one single measurement can take up to one second.	Only in process environment where a continuously material flow is guaranteed and a very high precision is necessary.

7.1.6. Selection of the individual Calibration Curves

In the menu "Calibration" and the window "Material Property Calibration" the calibration curves CAL1 to Cal15 which are stored in the SONO probe are loaded and displayed on the screen (takes max. 1 minute). With the mouse pointer individual calibration curves can be activated and tested with the SONO-probe by activating the button "Set Active Calib". Furthermore, the individual calibration curves CAL1 to Cal15 can be adapted or modified with the calibration coefficients (see Chapter "Creating a linear calibration curve").

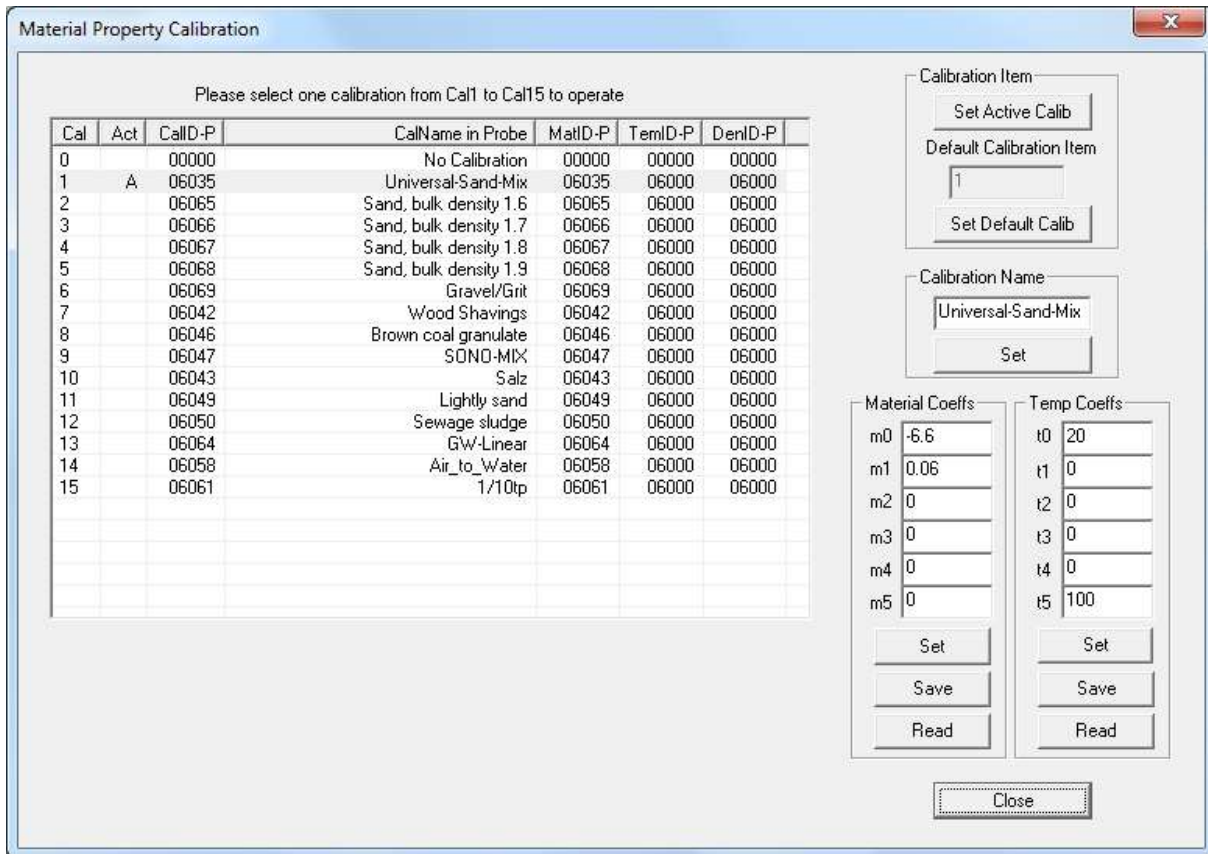

The desired and possibly altered calibration curve (Cal1. .15) which is activated after switching on the probes power supply can be adjusted with the button "Set Default Calib".

The calibration name can be entered in the window "Calibration Name".

The coefficients m0 to m1 (for linear curves) and m0 to m5 (for non-linear curves) can be entered and adjusted directly by hand with the buttons "Set" and "Save". Possible are non-linear calibration curves with polynomials up to fifth order (m0-m5).



Attention: Use "dot" as separator not comma, for coefficients m0 to m5 !

Determination of the parameters m0 and m1 for a linear calibration curve (see also chapter "Creating a linear calibration curve...")

1. Download the Excel-Sheet „SONO_LinearCalibration_Calculation“ from IMKO’s Homepage in the dropdown menu „Support Software“.
2. Enter into the Excel-Sheet both TP-values with the respective reference moisture values.
3. Read out both parameters m0 and m1 from the Excel-Sheet.
4. Enter, set and save both parameters m0 and m1 in the selected calibration curve.

7.1.8. Test run in the respective Measurement Mode

In the menu "Test" and the window "Test in Mode CA to CF" the measured moisture values "MoistAve" (Average) of the SONO probe are displayed on the screen and can be parallel saved in a file. In the menu "Test" and the window "Test in Mode CS" the measured single measurement values "Moist" (5 values per second) of the SONO probe are displayed on the screen and parallel stored in a file. In „Test in Mode A“ single measurement values (without average) are displayed on the screen and can also be stored in a file.



Attention: for a test run in mode CA, CH, CC, CF, CS or A it must be ensured that the SOI probe was also set to this mode (Measure Mode CA, CF, CS, A). If this is not assured, the probe returns zero values.

No.	Time	Date	MoistAve	MatTemp	EC-Trime	TDRave	DeltaCnt	tpAve	Moist1	Moist2	Moist3	Moist4	TDR1	TDR2	TDR3	TDR4
1	10:34:41	25-06-2015	5.00	23.70	0.18	84.52	2	193.46	4.94	4.99	-1.00	-1.00	84.5	84.5	-1.0	84.5
2	10:34:40	25-06-2015	4.99	23.70	0.18	84.52	3	193.30	5.09	5.09	4.89	-1.00	84.5	84.5	84.6	84.5
3	10:34:39	25-06-2015	4.98	23.70	0.17	84.56	3	193.20	4.95	4.94	4.94	-1.00	84.6	84.5	84.5	84.5
4	10:34:38	25-06-2015	5.01	23.70	0.15	84.60	2	193.63	4.98	5.11	-1.00	-1.00	84.6	84.6	-1.0	84.5
5	10:34:37	25-06-2015	5.00	23.70	0.16	84.58	3	193.49	5.14	4.96	4.87	-1.00	84.6	84.6	84.6	84.5
6	10:34:36	25-06-2015	4.97	23.70	0.16	84.58	3	192.95	4.89	4.96	5.09	-1.00	84.6	84.6	84.5	84.5
7	10:34:35	25-06-2015	4.92	23.70	0.17	84.54	2	192.17	4.89	5.02	-1.00	-1.00	84.6	84.6	-1.0	84.5
8	10:34:34	25-06-2015	4.94	23.70	0.18	84.52	3	192.47	4.94	4.96	4.81	-1.00	84.5	84.5	84.5	84.5
9	10:34:33	25-06-2015	4.97	23.70	0.17	84.56	3	193.00	4.97	4.95	5.05	-1.00	84.6	84.6	84.5	84.5
10	10:34:32	25-06-2015	4.97	23.70	0.17	84.54	2	192.93	4.95	4.96	-1.00	-1.00	84.5	84.6	-1.0	84.5
11	10:34:31	25-06-2015	4.96	23.70	0.18	84.52	3	192.66	5.07	4.80	5.08	-1.00	84.5	84.6	84.5	84.5
12	10:34:30	25-06-2015	4.89	23.70	0.17	84.56	3	191.60	4.87	4.84	4.99	-1.00	84.6	84.5	84.5	84.5
13	10:34:29	25-06-2015	4.91	23.70	0.17	84.56	2	191.99	4.87	4.89	-1.00	-1.00	84.6	84.6	-1.0	84.5
14	10:34:28	25-06-2015	4.93	23.70	0.18	84.52	3	192.20	4.92	4.85	5.04	-1.00	84.5	84.5	84.6	84.5
15	10:34:27	25-06-2015	4.90	23.70	0.17	84.54	3	191.84	4.96	4.99	4.84	-1.00	84.6	84.5	84.5	84.5
16	10:34:26	25-06-2015	4.91	23.70	0.17	84.54	2	192.05	4.85	4.89	-1.00	-1.00	84.5	84.6	-1.0	84.5
17	10:34:25	25-06-2015	4.93	23.70	0.17	84.54	3	192.30	4.93	4.94	4.98	-1.00	84.5	84.5	84.6	84.5
18	10:34:24	25-06-2015	4.88	23.70	0.17	84.56	3	191.39	4.98	4.96	4.85	-1.00	84.5	84.6	84.5	84.5
19	10:34:23	25-06-2015	4.84	23.70	0.16	84.58	2	190.86	4.73	4.87	-1.00	-1.00	84.6	84.6	-1.0	84.5
20	10:34:22	25-06-2015	4.88	23.70	0.17	84.54	9	191.46	4.87	4.83	4.82	4.95	84.6	84.5	84.6	84.5

Following measurement values are displayed on the screen:

- MoistAve** Moisture Value in % (Average)
- MatTemp** Temperature
- EC-TRIME** Radar-based-Conductivity EC-TRIME in dS/m (or mS/cm)
- TDRave** TDR-Signal-Level for special applications.
- DeltaCount** Number of single measurements which are used for the averaging.
- tpAve** Radar time (average) which corresponds to the respective moisture value.

By clicking „Save“ the recorded data is saved in a text file in the following path:
 \SONO-CONFIG.exe-PfadMD\Dateiname

The name of the text file **Statis+SN+yyyymmddHHMMSS.sts** is assigned automatically with the serial number of the probe (SN) and date and time. The data in the text file can be evaluated with Windows-EXCEL.

7.1.9. “Measure” Run in Datalogging-Operation

In the menu "Datalogging" it is possible to acquire and store measurement data from several SONO probes with variable and longer cycle rates in a datalogger-operation, e.g. to store measurement data during a long-term drying cycle.

7.1.10. Basic Balancing in Air and Water

SONO probe heads are identical and manufactured precisely. After an exchange of a probe head it is nevertheless advisable to verify the calibration and to check the basic calibration and if necessary to correct it with a "Basic Balancing".

With a "Basic Balancing" two reference calibration measurements are to be carried out with known set-points ("RefValues"). For the reference media, different calibration materials are used, dependent on the SONO probe type. For SONO probes with a ceramic measurement window, air and water (tap water) is used. For other SONO probes like SONO-GS1 glass beads are used for basic calibrations (on request).



Attention: Before performing a "Basic Balancing" it must be ensured that the SONO probe was set to "Measure Mode" A. If this is not assured, the probe returns zero values. After a "Basic Balancing" the SONO probe has to be set to "Measure Mode C" again, because otherwise the probe would not measure continuously!

In the menu "Calibration" and the window "Basic Balancing" the two set-point values of the radar time **tp** are displayed with 60ps and 1000ps.

1. Reference set-point A: **tp**=60ps in air (the surface of the probe head must be dry!!)
The first set-point can be activated with the mouse pointer by clicking to No.1. By activating the button "**Do Measurement**" the SONO probe determines the first reference set-point in air. In the column „MeasValues“ the measured raw value of the radar time **t** is displayed (e.g. 1532.05 picoseconds).
2. Reference set-point B: **tp**=1000ps in water. The SONO probe head has to be covered with water in a height of about 50mm. The second set-point can be activated with the mouse pointer by clicking to No.2. By activating the button "**Do Measurement**" the SONO probe determines the second reference set-point in water. In the column „MeasValues“ the measured raw value of the radar time **t** is displayed.
3. By activating the button „**Calculate Coeffs**“ and „**Coeffs → Probe**“ the alignment data is calculated automatically and is stored in the SONO probe non-volatile. With a "Test run" (in Mode A) the radar time **tp** of the SONO probe should be now 60ps in air and 1000ps in water.

Basic Balancing X

No	RefValues(tp)/ps	MoistValues(%)	MeasValues(t)/ps	Comments
1	60.0	0.0		air
2	1000.0	100.0		water

Coefficients	<Calculated>	<in File>	<in Probe>
b0			-1889.74
b1			1.24275

air and water ▼

Do Measurement

Calculate Coeffs

Coeffs --> Probe

Close

7.1.11. Offsetting the material temperature sensor

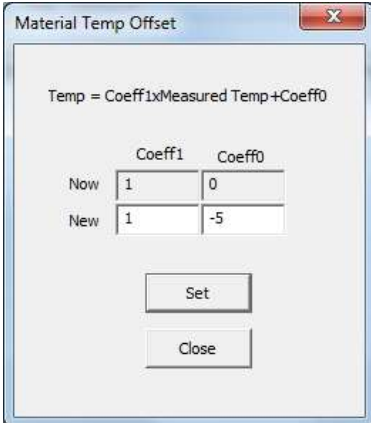

Material Temp Offset

Temp = Coeff1xMeasured Temp+Coeff0

	Coeff1	Coeff0
Now	1	0
New	1	-5

Set

Close

In the menu „**Calibration**“ and the window „**Material Temp Offset**“, a zero point offset can be adjusted for the material temperature sensor which is installed inside the SONO probe. In this example a temperature deviation of +5° C is produced by inside self-warming of the SONO probe. The correction value -5 can be set in the Coeff0 window.

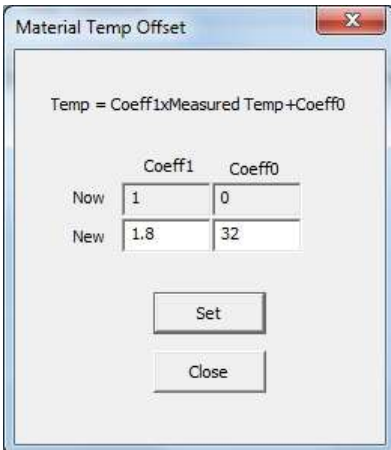

Material Temp Offset

Temp = Coeff1xMeasured Temp+Coeff0

	Coeff1	Coeff0
Now	1	0
New	1.8	32

Set

Close

The example shows the parameters for displaying the temperature in the unit: Degree Fahrenheit.

7.1.12. Compensation of the electronic temperature

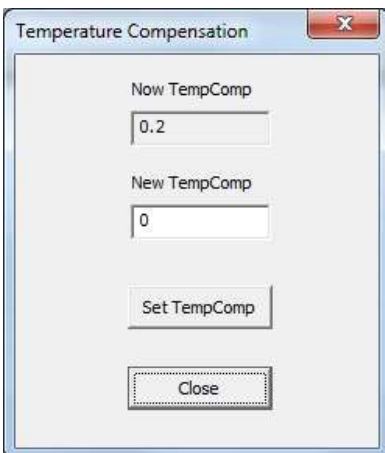

Temperature Compensation

Now TempComp

0.2

New TempComp

0

Set TempComp

Close

With this method of temperature compensation, a possible temperature drift of the SONO-electronic can be compensated. Because the SONO-electronic shows a generally low temperature drift, SONO probes are presetted at delivery for standard ambient conditions with the parameter **TempComp**=0.2. Dependent on SONO probe type, this parameter TempComp can be adjusted for higher temperature ranges (up to 120°C for special high temperature version) to values up to **TempComp**=0.75. But it is to consider that it is necessary to make a Basic-Balancing of the SONO probe in air and water, if the parameter TempComp is changed to another value as TempComp=0.2. The parameter TempComp can be changed with the software tool SONO-CONFIG, in the menu "**Calibration**" and the window "**Electronic-Temperature-Compensation**".



Attention: When changing the TempComp parameter, a new basic balancing of the SONO probe is necessary!

8. Technical Data TRIME-GWs

Power supply:	12V..24V-DC 3W
Power consumption:	Dependent on the power supply: 12V to 24V-DC 200mA consumption
Measuring range:	5..45% by weight (b.w.) on a wet mass basis (depends on the used material)
Standard deviation:	range 5..20 % b.w.: 0.6 % b.w. range 20..45 % b.w.: 1 % b.w. (depends on the used material)
Repeatability:	± 0.3 % b.w. (depends on the used material)
Measurement transformer temperature range:	-10..70 °C, extended range on request
Probe temperature range:	0..127°C; temporarily up to 150°C
Measuring period / -interval:	floating average with adjustable time interval
Interface:	RS485 and IMP-Bus
Analogue output:	0(4)...20 mA = 0 .. 100% gravimetric moisture (max. load: 500 Ω)
Cable length of probe:	Standard 2.5 meter
Housing protection:	Aluminium diecasting IP65
GR-Probe protection:	IP68 watertight casting

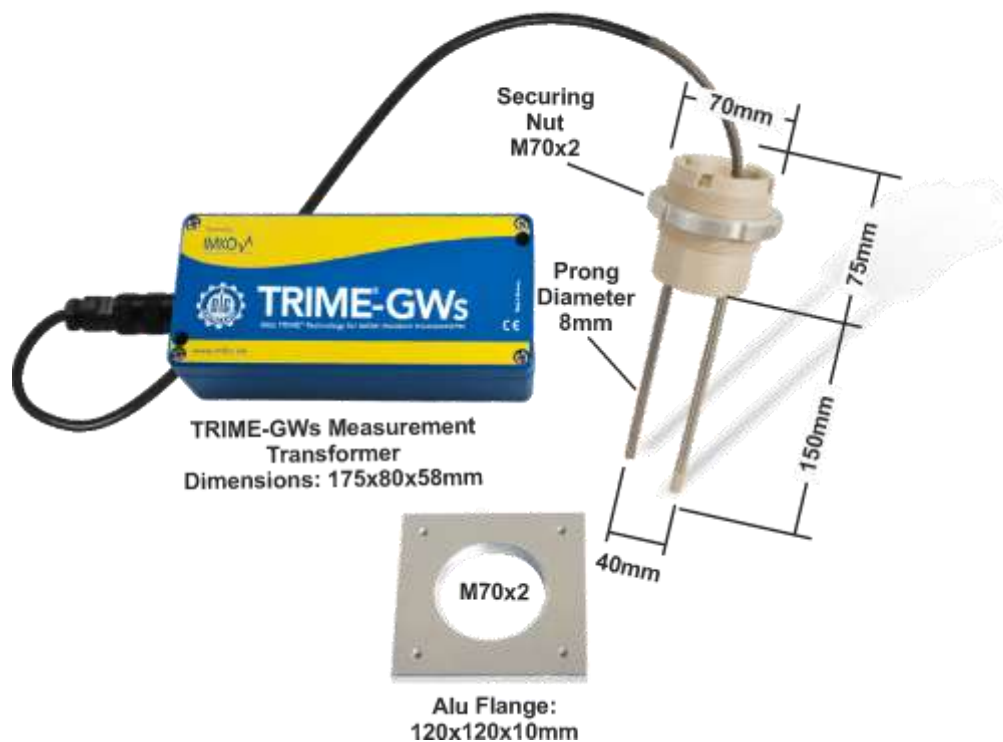

9. Safety Notes

In this documentation, text points are highlighted, which require special attention.



DANGER:

The Warning Triangle with the exclamation mark warns you against personal injury or property damage.

Intended Use

Sensors and measuring systems of IMKO GmbH may only be used for the purpose described, taking into account the technical data. Misuse **and use of the equipment** other than for its intended purpose **are not eligible**. The function and operational safety of a sensor or measuring system can only be guaranteed if the general safety precautions, national regulations and the special safety instructions in this operating manual are observed during use.

The moisture sensors and measuring systems of IMKO GmbH are used to measure moisture according to the measuring purpose and measuring range defined and defined in the technical data. Only adherence to the instructions described in the manual is regarded as intended use. The manual describes the connection, use and maintenance of IMKO sensors and IMKO measuring systems. Read the manual before connecting and operating a sensor or measuring system. The manual is part of the product and must be kept close to the sensor or measuring system.



Impairment of safety

The sensor or the measuring system has been designed and tested in accordance with EN 61010 safety regulations for electronic measuring instruments and has left the factory in a safe and safe condition. If the sensor or the measuring system can no longer be operated safely, it must be put out of operation and secured by means of marking before further commissioning. In case of doubt, the sensor or the measuring system must be sent to the manufacturer or his contractual partner for repair or maintenance.



Modifications

For safety reasons, it is not permitted to carry out any modifications or modifications to the sensor or the measuring system without the consent of the manufacturer. The opening of the sensor or hand-held meter, adjustment and repair work, as well as all maintenance work other than the work described in the manual may only be carried out by a specialist authorized by IMKO. The sensor or the measuring system must be disconnected from the power supply before installation or maintenance work. Do not open or repair the hand-held unit and the power supply!



Hazard Warnings

Danger due to improper operation. The sensor or the measuring system may only be operated by instructed personnel. The operating personnel must have read and understood the operating instructions.

**Danger by electricity**

The hand-held meter must not be immersed in water or other liquids. The sensor is insensitive to moisture contained in the typically measured products. Only connect the hand-held meter to a properly installed outlet with the supplied voltage supply cable, the voltage of which corresponds to the technical data. Make sure that the power outlet is well accessible, so that you can unplug the power supply quickly if necessary. Use only the adapter that is suitable for your outlet.

Only operate the meter with the supplied original accessories. If you need additional accessories or replacement, please contact the manufacturer.

Do not use the meter in following case:

- if the measuring instrument, sensor, plug-in power supply or accessories are damaged,
- the sensor or the measuring system does not operate as intended,
- the power cord or plug is damaged,
- the sensor or the measuring system has fallen down.

Unplug the power supply from the wall outlet in following case:

- if you do not use the sensor or the measuring system for an extended period of time,
- before cleaning, unpacking or changing the sensor or the measuring system,
- if you are working inside the sensor or measuring instrument, e.g. connect devices,
- if a fault occurs during operation,
- during thunderstorms.

**Caution - Property damage**

Ensure that there is a sufficient distance to strong heat sources such as heating plates, heating pipes. Disconnect the sensor or handheld device from other devices before relocating or transporting it. Disconnect the connectors on the device.

Do not use aggressive chemical cleaning agents, scouring agents, hard sponges or the like.

Precise Moisture Measurement

in industry, hydrology, forestry, agriculture, environmental and earth science, civil engineering, as well as individual applications!