

USER MANUAL



AR682



AR642



AR662



AR692



AR602



AR652

AR632



PROGRAMMABLE MICROPROCESSOR CONTROLLERS



Thank you for choosing our product.

This manual will help you use your controller correctly, safely and to its full potential.

Read this manual carefully before installing and putting your controller to use.

In case of additional questions, please contact the technical advisor.

CONTENTS

1. SAFETY RULES	3
2. INSTALLATION RECOMENDATION.....	3
3. GENERAL FEATURES OF CONTROLLERS	3
4. KIT.....	4
5. TECHNICAL SPECIFICATION	4
6. DIMENSIONS AND INSTALLATION DATA.....	6
7. DESCRIPTION OF TERMINAL STRIPS AND ELECTRICAL CONNECTIONS	7
8. IMPORTANT TIPS – using the suppression systems	8
9. DESCRIPTION OF BUTTONS AND SIGNAL LED INDICATORS	9
9.1. FUNCTION BUTTON AND BINARY INPUT.....	9
10. SETTING THE CONFIGURATION PARAMETERS.....	10
11. QUICK ACCESS MENU	14
12. OUTPUTS CONFIGURATION	14
12.1. CHANGING THE OUTPUTS SET VALUES	14
12.2. TYPES OF OUTPUT CHARACTERISTICS.....	15
12.3. ANALOGUE OUTPUT	16
12.4. PID CONTROL.....	16
12.5. AUTOMATIC SELECTION OF PID PARAMETERS	17
12.6. ADJUSTMENT OF PID PARAMETERS.....	18
12.7. PROGRAMMABLE CHARACTERISTICS (RAMPING).....	18
12.8. MANUAL AND REMOTE CONTROL OPTION.....	19
13. ERRORS AND MESSAGES	19
14. CONNECTING TO THE PC AND AVAILABLE SOFTWARE.....	19
15. RS485 COMMUNICATION INTERFACE (acc. to EIA RS-485)	20
16. MODBUS–RTU SERIAL TRANSMISSION PROTOCOL (SLAVE).....	21
17. NOTES	23



Please pay particular attention to fragments marked with this sign.

The manufacturer reserves its rights to modify the design and software of the device without deteriorating its technical parameters.

1. SAFETY RULES

- read this manual carefully before starting to use the device;
- to prevent the hazard of electric shock or equipment damage the mechanical and electrical installation should be performed by qualified personnel;
- before powering the device make sure all leads have been connected correctly;
- disconnect the power supply before making any modifications of the leads configurations;
- ensure correct operating conditions (supply voltage, temperature, humidity, see section 5).

2. INSTALLATION RECOMMENDATION

The controller has been designed to provide an adequate level of immunity to most disturbances which can appear in industrial environments. In environments with unknown disturbance level it is recommended to use the following preventive measures:

- without proper line filters do not provide the power supply to the controller from the same lines which supply large equipment;
- use screened power supply, sensor and signal cables; the screen earthing shall be one-point type, located as close to the device as possible;
- avoid placing the measuring (signal) leads in direct vicinity of and parallel to power supply cables or lines;
- it is recommended to twist the signal leads in pairs;
- use identical leads for resistance sensors in 3-lead connection;
- avoid proximity of remotely controlled devices, electromagnetic meters, large electrical loads, loads with phase or group power control, and other devices generating large pulse disturbance;
- provide earthing or neutralization to metal rails on which the rail-mounted devices are installed.

Before using the device, remove the screen protective film from LED display.

3. GENERAL FEATURES OF CONTROLLERS

- control and supervision of temperature and other physical magnitudes (humidity, pressure, level, velocity, etc.) converted to standard electrical signal (0/4÷20mA, 0÷10V, 0÷60mV, 0÷2.5kΩ);
- 1 multi-purpose measuring input (resistance thermometers, thermocouple, and analogue);
- Programmable digital input and function button to change the controller operation mode: start/stop regulation, manual mode for output, step change set value (daily/night), lock keypad;
- 2 or 3 ON-OFF outputs with the following control characteristics:
 - output 1 (main): ON-OFF with hysteresis, PID, PID AUTOTUNING
 - output 2, 3 (auxiliary/alarm): ON-OFF with hysteresis
- 0/4÷20mA or 0/2÷10V analogue outputs (control-continuous, retransmission);
- possible conversion of input signals to the analogue output standard in the signal retransmission mode;
- advanced function of PID parameters selection with fuzzy logic elements;
- manual mode (open control loop) available to switching and analogue outputs allowing to set the input signal value in the 0 ÷ 100% range, the ability to auto-activation for (input) sensor failure;
- programmable programmable operating characteristics (process controller, ramping)
- built-in 24Vdc power supply to supply field transmitters;
- two-line LED display with brightness adjustment **TOP** display – measured value, **BOTTOM**– input 1_set value;
- RS485 serial interface (galvanically isolated, MODBUS-RTU protocol);
- programmable input type, range of indications (for analogue inputs), options of control, alarms, communication, access, and other configuration parameters;
- line resistance compensation for resistance and thermocouple cold junction compensation;
- password-protected access to configuration parameters;

- methods of parameters configuration:
 - from the keypad on the controller front panel;
 - via RS485 or AR955 programming device and ARSOFT-WZ1 freeware (Windows 2000/XP/Vista/7)
- software and AR955 programming device which allows viewing the measured value and a quick configuration of single or ready-to-use parameter sets previously saved in the computer to be reused, for example in other controllers of the same type (configuration duplication);
- board enclosure (IP65 front, IP54 - AR692), AR662 - enclosure for installation on the DIN 35 mm rail (IP20) AR632 - IP65 industrial enclosure;
- options (specify in the purchase order): 24Vac/dc power supply, SSR control outputs, 0/2÷10V analogue output, and RS485 interface;
- high accuracy, long-term stability and immunity to disturbance;
- available accessories:
 - AR955 programming device (with optional adapted for AR602 – version AR955/GP)
 - RS485/USB converter



NOTE: 

Before starting to use the controller read this manual and correctly perform the electrical, mechanical installation and the parameter configuration.

4. KIT

- controller with fastening holders to install in the board window;
- user manual
- warranty card

5. TECHNICAL SPECIFICATION

1 multi-purpose input (set using the 0:  parameter)	Measuring range
- Pt100 (RTD, 3- or 2-lead)	-200 ÷ 850 °C
- Ni100 (RTD, 3- or 2-lead)	-50 ÷ 170 °C
- Pt500 (RTD, 3- or 2-lead)	-200 ÷ 620 °C
- Pt1000 (RTD, 3- or 2-lead)	-200 ÷ 520 °C
- thermocouple J (Fe-CuNi)	-40 ÷ 800 °C
- thermocouple K (NiCr-NiAl)	-40 ÷ 1200 °C
- thermocouple S (PtRh 10-Pt)	-40 ÷ 1600 °C
- thermocouple B (PtRh30PtRh6)	300 ÷ 1800 °C
- thermocouple R (PtRh13-Pt)	-40 ÷ 1600 °C
- thermocouple T (Cu-CuNi)	-25 ÷ 350 °C
- thermocouple E (NiCr-CuNi)	-25 ÷ 820 °C
- thermocouple N (NiCrSi-NiSi)	-35 ÷ 1300 °C
- current ($R_{we} = 50 \Omega$)	0/4 ÷ 20 mA
- voltage ($R_{we} = 110 \text{ k}\Omega$)	0 ÷ 10 V
- voltage ($R_{we} > 2 \text{ M}\Omega$)	0 ÷ 60 mV
- resistance (3- or 2-lead)	0 ÷ 2500 Ω
Response time (10 ÷ 90%)	0,25 ÷ 3 s (set using the 1:  parameter)
Leads resistance (RTD, Ω)	$R_d < 25 \Omega$ (for each line)

Resistance input current (RTD, Ω)		400 μ A (Pt100, Ni100), 200 μ A (remaining)
Processing errors (at 25°C ambient temperature):		
- basic	- dla RTD, mA, V, mV, Ω	0.1 % of measuring range \pm 1 digit
	- for thermocouples	0.2 % of measuring range \pm 1 digit
- additional for thermocouples		<2 °C (cold ends temperature)
- additional caused by ambient temperature changes		< 0.003 % of input range /°C
Resolution of measured temperature		0.1 °C or 1 °C, programmable
Indication range (analog inputs resolution)		-1999 ÷ 9999, programmable
Decimal point position for analog inputs		0 ÷ 0,000, programmable
Binary inputs (contact or voltage <24V)		Bistable, active level: short-circuit or < 0.8V
Communication interfaces (RS485 and PRG, do not use at the same time)	- RS485 (galvanically separated), option	- bitrate 2.4 ÷ 115.2 kb/s, - format 8N1 (8 data bits, no parity bit, 1 stop bit)
	- PRG programming link (no separation), standard	- MODBUS-RTU protocol (SLAVE)
Switching outputs (3 or 2 for AR602, relay type or SSR type)	- relay (P1, P2, P3), standard (P3 unavailable to AR602)	8A / 250Vac 1 main (SPDT), 2 additional (SPST-NO), AR602, AR662: 5A / 250Vac (SPST-NO), AR632: 1 main (SPDT) - 8A / 250Va, 2 additional (SPST-NO) - 5A / 250Vac, for resistive loads
	- SSR (SSR1, SSR2, SSR3), option (SSR3 unavailable to AR602)	transistor, type NPN OC, 10,5 ÷ 11V, internal resistance 440 Ω AR632, AR692 – current sources about 22mA / 10V
Analogue outputs (1 current or voltage, not separated from the input)	- current 0/4 ÷ 20 mA (standard)	maximum resolution 1.4 μ A (14 bit) output load R_o < 350 Ω
	- voltage 0/2 ÷ 10 V (option, instead of 0/4 ÷ 20 mA output)	maximum resolution 0.7 mV (14 bit) output load I_o < 3.7 mA (R_o > 2.7k Ω)
	- output basic error	< 0.1 % of output range
7-segment LED display (2 lines with 4 digits each, brightness control)	- top	red, height: 14 mm (AR652, AR632), 20mm (AR682), 9mm (AR642, AR602), 10mm (AR662), 25mm (AR692)
	- bottom	green, height: 10 mm (AR652, AR632), 14mm (AR682, AR692), 9mm (AR642), 7mm (AR602, AR662)
Signalling	- relays active	LED's, red
	- messages and errors	LED display
Power supply (Usup)	- 230Vac (standard)	85 ÷ 260 Vac/ 3VA
	- 24Vac/dc (option)	20 ÷ 50 Vac/ 3VA, 22 ÷ 72 Vdc/ 3W
Power supply to field transmitters		24Vdc / 30mA
Rated operating conditions		0 ÷ 50°C, <90 %RH (non-condensing)
Working environment		air and neutral gases
Protection rating	AR632 - IP65, AR662 - IP20, remaining IP65 front (AR692 - IP54), IP20 of the connections side	
Weight	~200g (AR652, AR642), ~280g (AR682), ~135g (AR602), ~160g (AR662), ~310g (AR692), ~320g (AR632)	
Electromagnetic compatibility (EMC)		immunity: acc. to PN-EN 61000-6-2:2002(U)
		emission: acc. to PN-EN 61000-6-4:2002(U)

6. DIMENSIONS AND INSTALLATION DATA

a) AR652, AR642, AR602

Enclosure type	board-type, Incabox XT L57
Material	self-extinguishing polycarbonate NORYL 94V-0
Enclosure dimensions (W x H x D)	AR652: 96x48x79mm, AR642: 48x96x79mm AR602: 48x48x79mm
Window in the board (W x H)	AR652: 92 x 46 mm, AR642: 46x92mm, AR602: 46 x 46 mm
Fastening	holders on the enclosure side
Leads cross sections (for separable connections)	2.5mm ² (power and binary outputs), 1.5mm ² (remaining)

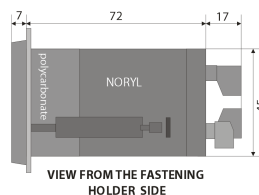

b) AR682

Enclosure type	board-type, Incabox XT L57
Material	self-extinguishing polycarbonate NORYL 94V-0
Enclosure dimensions	96 x 96 x 79mm (W x H x D)
Window in the board	92 x 89 mm (W x H)
Fastening	holders on the enclosure side
Leads cross sections (for separable connections)	2.5mm ² (power and binary outputs), 1.5mm ² (remaining)

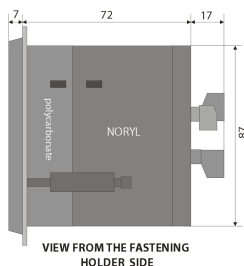

c) AR662

Enclosure type	rail, Modulbox 3MH53
Material	ABS/PC
Enclosure dimensions	53 x 90 x 62 mm (W x H x D)
Fastening	on the TS35 rail (DIN EN 50022-35)
Leads cross sections (for separable connections)	2.5mm ² (power and binary outputs), 1.5mm ² (remaining)

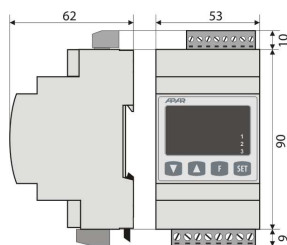

d) AR692

Enclosure type	board-type, Incabox L57
Material	self-extinguishing NORYL 94V-0
Enclosure dimensions	144 x 72 x 72 mm (W x H x D)
Window in the board	138 x 67 mm (W x H)
Protective cover IP54	AR967 (option)
Fastening	holders on the enclosure side
Leads cross sections (for separable connections)	2.5mm ² (power and binary outputs), 1.5mm ² (remaining)

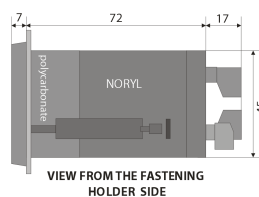

d) AR632

Enclosure type	industrial IP65, Gainta G2104
Material	polycarbonate
Enclosure dimensions	120 x 80 x 55 mm (W x H x D)
Fastening	4 dia 4.3 mm holes, spacing 108x50 mm, accessible after removing the front cover
Leads cross sections (for separable connections)	2.5mm ² (power and binary outputs), 1.5mm ² (remaining)

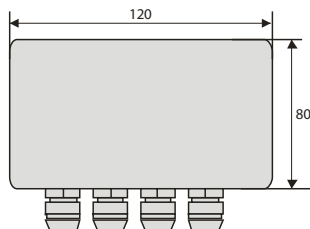

7. DESCRIPTION OF TERMINAL STRIPS AND ELECTRICAL CONNECTIONS

Table 7. Number and designation of terminals

Terminals	Description
1-2-3	Pt100, Ni100, Pt500, Pt1000 resistance input, (2- and 3-lead)
2-3	TC (J, K, S, B, R, T, E, N) thermocouple input and 0÷60mV voltage input
3-5	0/4÷20mA current input
4-5	0÷10V voltage input
6	+24V input (in relation 5-GND) of the built-in power supply for field transmitters
5-7	binary input (contact or <24V voltage)
5-8	analogue current output (0/4÷20mA) or voltage (0/2÷10V)
PRG	programming connection for the programming device (only AR955)
9-10 (7-8 for AR602)	RS485 serial interface (MODBUS-RTU protocol), in AR602 the RS485 interface rules out the analogue output and binary input (acc. to the purchase order code)
12-13	230Vac or 24Vac/dc power supply input
14-15-16	P1 or SSR1 relay output (14-15), for AR602 P2 or SSR2 output: 14-15
17-18	P2 or SSR2 relay output, for AR602 P1 or SSR1 output
19-20 (except AR602)	P3 or SSR3 relay output

a.1) AR642, AR652, AR682 – terminals description Table 7

a.2) AR602 – terminals description Table 7

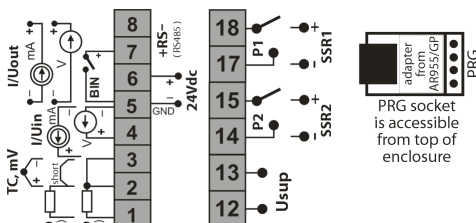
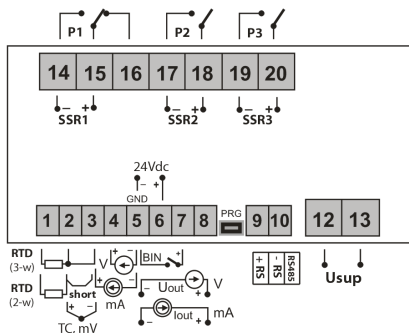

a.3) AR692, AR632 – terminals description Table 7 (in AR632 PRG socket is accessible on the display board)

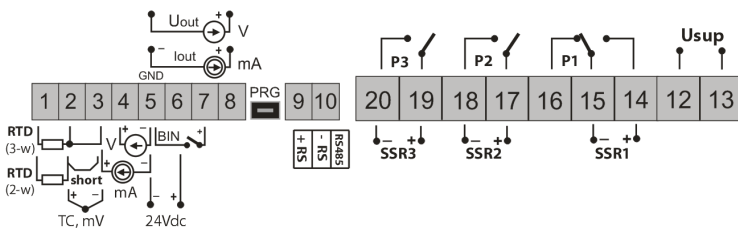

NOTE:

To install the cabling in the **AR632**, follow the instructions given below:

- remove 4 bolts in the front panel and remove the panel;
- fasten the controller to the base using 4 screws and fastening holes;
- remove one bolt on the display board and carefully pull out the board from its seats;

- now you have access to terminals to connect the signal, power supply, and relay outputs leads;
- insert the leads to the controller through cable glands;
- after connecting, reassemble the controller in reverse order;
- to get the IP65 rating, precisely tighten the glands' nuts and the enclosure cover;
- to prevent mechanical and electrostatic damage, exercise particular caution when handling the display board.

a.4) AR662 – terminals description Table 7

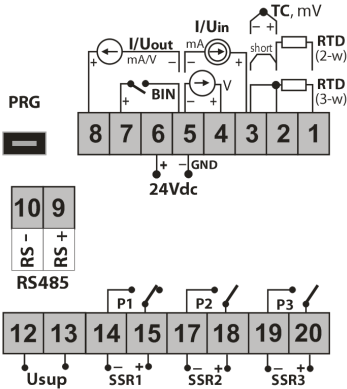

NOTE:



To connect to the computer via the **PRG** socket, use only the **AR955** programming device (with optional adapter for AR602). Connection using the simple USB cable can damage the controller.

b) connecting 2- and 3-lead transmitter (Iout - current, Uout – output voltage)

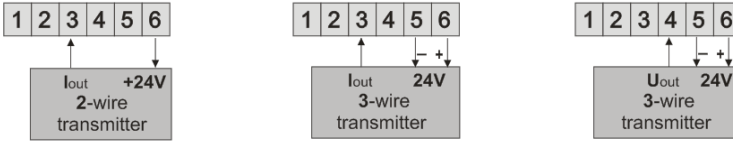

8. IMPORTANT TIPS – using the suppression systems

 If an inductive load (e.g. contactor coil, transformer) is connected to the relay contacts, overvoltage and arc appear often during opening as a result of discharge of energy accumulated in the inductance. Particularly harmful effects of such overvoltage include reduced life of contactors and relays, destruction of semiconductors (diodes, thyristors, triacs), damage or disturbance of control and measurement systems, emission of electromagnetic fields causing interference with local devices. To avoid such effects, the overvoltage must be reduced to a safe level. The easiest method is connecting a suitable suppression module **directly** to the inductive load terminals. Generally, a suitable type of suppression system should be selected for each inductive load. Modern contactors usually have factory-installed suitable suppression systems. If they do not, a contactor with a built-in suppression system should be bought. Temporarily, you can shunt the load using the RC system, e.g. $R=47\Omega/1W$ and $C=22nF/630V$. Connect the suppression system to the inductive load terminals. This will limit burning of the relays contacts in the controller and reduce the probability that they will get stuck.

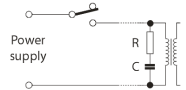





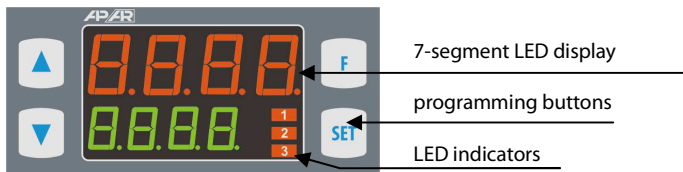

9. DESCRIPTION OF BUTTONS AND SIGNAL LED INDICATORS





Description the front elevation for example AR652





a) functions of buttons in the measurement display mode

Button	Description [and designation in the manual]
 or 	[UP] or [DOWN] : change set value for input 1 (parameter 9: SEt 1 , or 26: MSSEt when output 1 is in manual mode (see sections 10 and 12.8)
	[SET] : - go to the quick access menu (see section 11)
 + 	[UP] and [DOWN] (simultaneously): go to the parameter configuration menu (if pressed for longer than 1 s). If the parameter 33: PPPrd = on (password protection on), enter the access password, section 10)
	[F] (unavailable in AR602): start the function programmed by parameter 34: Funct (if pressed for longer than 1 s, sections 9.1 and 10)

b) functions of buttons in the parameter configuration menu and quick access menu (sections 10 and 11)

Button	Description [and designation in the manual]
	[SET] : - edit current parameter (the value in the bottom display is flashing) - confirm and save the edited parameter
 or 	[UP] or [DOWN] : - go to the next parameter - change the value of current parameter
 + 	[UP] and [DOWN] (simultaneously): - cancel the modifications of edited value (flashing stops) - return to the measurement display mode (if held for > 0.5s)



c) functions of signal LED indicators

LED indicators [designation]	Description
   [1] [2] [3]	inputs P1/SSR1, P2/SSR2, P3/SSR3 are on

9.1. FUNCTION BUTTON AND BINARY INPUT

Function button **[F]** (unavailable in AR602) and binary input **BIN** perform the same function programmable by parameter 34: **Funct** (section 10). The binary input cooperates with the bistable signal, i.e. the received signal (voltage or switch) must be of durable character (on/off type). In addition, the **[F]** is inactive when the **BIN** is active (short-circuit or voltage <0.8V). Starting and stopping of the function is signalled by relevant message on the bottom display (described in Table 9.1).

Table 9.1. Available functions of button **[F]** and input **BIN**

Source	Description (depending on the value of parameter 34: Func)	Message	
 or  BIN	Func = nonF	button [F] and input BIN inactive (factory setting)	-
	Func = SEt3	discrete change of set value for P1/SSR1 output (day = parameter 9: SEt1 /night = 16: SEt3 , Table 10)	SEt1 / SEt3
	Func = blOc	keypad locked (except button [F])	blOc / boFF
	Func = hAn1	unconditional manual mode for output P1/SSR1 (section 12.8)	hAn1 / hoFF
	Func = hAn2	unconditional manual mode for output P2/SSR2	hAn2 / hoFF
	Func = hAn3	unconditional manual mode for output P3/SSR3	hAn3 / hoFF
	Func = hAnA	unconditional manual mode for analogue output	hAnA / hoFF
	Func = StoP	control start/stop (applies to all outputs)	StAn / StoP

10. SETTING THE CONFIGURATION PARAMETERS

All configuration parameters are stored in a non-volatile internal memory. When the controller is switched on for the first time, an error message may appear indicating that there is no sensor or that the sensor is different than programmed. Connect the right sensor or perform the configuration programming.

There are two methods of parameter configuration:

1. Using the keypad on the front panel:

- from the measurement display mode go to the configuration menu (simultaneously press **[UP]** and **[DOWN]** buttons for longer than 1 s). If the parameter 33: **PPrO** = **on** (password protection on), the display will show the message **Code** and then **0000** with the first digit flashing. Use the **[UP]** or **[DOWN]** buttons to enter the access password (default parameter 32: **PRSS** = **1111**). Use the **[SET]** button to go to successive positions and to approve the code;
- after entering the configuration menu (with the **Conf** message) the main display shows the mnemonic name of the parameter (**inP** <-> **File** <-> **Obj** <->, etc.), and the bottom one its value;
- use the **[UP]** button to go to the next parameter, and the **[DOWN]** button to return to the previous parameter (the list of all parameters is given in table 10);
- to change the value of selected parameter, briefly press **[SET]** (flashing in the edit mode);
- change the value of parameter using **[UP]** or **[DOWN]** buttons;
- confirm new value by pressing **[SET]** or cancel: **[UP]** and **[DOWN]** (press simultaneously briefly) and the display will again show the parameter name;
- to exit the configuration menu: press **[UP]** and **[DOWN]** simultaneously for a longer time. The controller will exit the configuration menu automatically after about 2 min. of inactivity.

2. Via the RS485 port or PRG (AR955 programming device) and the ARSOFT-WZ1 application (section 14):

- connect the controller to the computer, start and configure the ARSOFT-WZ1 application
- when the connection is made, the program window will show the current measured value
- setting and viewing of parameters is possible in the parameter configuration window
- press the **Accept Changes** button to approve new values
- current configuration can be saved in a file or set using the values read from the file
- file with ready configuration can also be created using the ARSOFT-WZ4 application (section 14)

NOTE:

- before disconnecting the controller from the computer press the **Disconnect Device** button (ARSOFT-WZ1)
- if the program does not respond:
 - in **Program Options** check the port configuration and the **MODBUS device address**
 - make sure that the serial port drivers in the computer have been correctly installed for the RS485 converter or the AR955 programming device
 - disconnect the RS485 converter or the AR955 programming device for a few seconds and then reconnect
 - restart your computer

If the indications are different that actual input signal value, you can tune the zero and sensitivity to a given sensor: parameters 38: **zAL0** (zero) and 39: **sAL0** (sensitivity).

To restore factory settings: on powering up press **[UP]** and **[DOWN]** until the password menu appears (**Code**), and then enter the **0112** code. Alternatively, use the file with default configuration in the ARSOFT-WZ1 application.

NOTE:

Do not configure the device from the keypad and via the serial interface (RS485 or AR955) at the same time.

Table 10. List of all configuration parameters

Parameter	Parameter range and description		Default settings
0: inp type of measuring input	PE	thermal resistant sensor (RTD) Pt100 (-200 ÷ 850°C)	PE
	n1	thermal resistant sensor (RTD) Ni100 (-50 ÷ 170°C)	
	PE5	thermal resistant sensor (RTD) Pt500 (-200 ÷ 620°C)	
	PE10	thermal resistant sensor (RTD) Pt1000 (-200 ÷ 520°C)	
	tc-J	thermoelectric sensor (thermocouple) J (-40 ÷ 800°C)	
	tc-K	thermoelectric sensor (thermocouple) K (-40 ÷ 1200°C)	
	tc-S	thermoelectric sensor (thermocouple) S (-40 ÷ 1600°C)	
	tc-B	thermoelectric sensor (thermocouple) B (300 ÷ 1800°C)	
	tc-R	thermoelectric sensor (thermocouple) R (-40 ÷ 1600°C)	
	tc-T	thermoelectric sensor (thermocouple) T (-25 ÷ 350°C)	
	tc-E	thermoelectric sensor (thermocouple) E (-25 ÷ 820°C)	
	tc-N	thermoelectric sensor (thermocouple) N (-35 ÷ 1300°C)	
	4-20	4 ÷ 20 mA current signal	
	0-20	0 ÷ 20 mA current signal	
	0-10	0 ÷ 10 V voltage signal	
0-60	0 ÷ 60 mV voltage signal		
RES	0 ÷ 2500 Ω resistance signal		
1: Filt filtration (1)	1 ÷ 20	digital filtration of measurements (response time)	5
2: dot dot position/resolution	0	no dot (2) or 1°C resolution for temperature	1 (0.1°C)
	1	0.0 (2) or 0.1°C resolution for temperature	
	2	0.00 (2)	
	3	0.000 (2)	

3: L01 low limit 1 or bottom of indications range (2)	4999 ÷ 1800	low settings limit for the set value 9: 555.1	4999 °C
	4999 ÷ 9999	indications for 0/4mA, 0V, 0Ω – beginning of input scale (2)	
4: H11 high limit 1 or top of indications range (2)	4999 ÷ 1800	high settings limit for the set value 9: 555.1	8500 °C
	4999 ÷ 9999	indications for 20mA, 10V, 60mV, 2500Ω – end of input scale (2)	
5: L02 low limit 2	4999 ÷ 1800	low settings limit for the set value 13: 555.2	4999 °C
	3: L01 ÷ 4: H11	low settings limit for 9: 555.1 and 13: 555.2 (2)	
6: H12 high limit 2	4999 ÷ 1800	high settings limit for the set value 13: 555.2	8500 °C
	3: L01 ÷ 4: H11	low settings limit for 9: 555.1 and 13: 555.2 (2)	
CONFIGURATION OF MAIN OUTPUT (P1/SSR1) - section 12 (12.2)			
7: F001 emergency state of output 1 (3)	output state when the sensor (signal) absent or damaged: noCh = no change, OFF or on , hRnd = manual mode with set value = 26: 4555 (section.12.8)		noCh
8: out1 function of output 1	OFF , hRnd = manual mode (section.12.8), mu = heating, dir = cooling		mu
9: 555.1 set value 1	for output 1, changes in the range 3: L01 ÷ 4: H11 or 5: L02 ÷ 6: H12 (2)		1000 °C
10: H1 hysteresis of output 1 or PID tuning zone	hysteresis or PID tuning insensitiveness zone in the RuLo mode, section 12.5, 00 ÷ 9999 °C or 0 ÷ 9999 units (2)		10 °C
CONFIGURATION OF AUXILIARY OUTPUTS (P2/SSR2 and P3/SSR3) - section 12			
11: F002 emergency state of output 2 (3)	output state when the sensor (signal) absent or damaged: noCh = no change, OFF or on , hRnd = manual mode with set value = 26: 4555 (section.12.8)		noCh
12: out2 function of output 2 (section 12.2)	OFF , hRnd = manual mode, mu = heating, dir = cooling, bRon or bRoF = band 2* 555.2 around 555.1 , dEoF or dEon = deviation from 555.1 , rEon , rEoF , rEP3 = controlled by the ramping controller (ramping), sec. 12.7		mu
13: 555.2 set value 2	for output 1, changes in the range 5: L02 ÷ 6: H12 (2)		1000 °C
14: H2 hysteresis of output 2	00 ÷ 9999 °C or 0 ÷ 9999 units (2)		10 °C
15: out3 function of output 3 (section 12.2)	OFF , hRnd = manual mode, mu = heating, dir = cooling, bRon or bRoF = band 2* 555.3 around 555.1 , dEoF or dEon = deviation from 555.1 , rEon , rEoF , rEP3 = controlled by the ramping controller (ramping), sec. 12.7		OFF
16: 555.3 set value 3	for output 3, 4999 ÷ 1800 or 4999 ÷ 9999 units (2)		1000 °C
CONFIGURATION OF ANALOGUE OUTPUT (section 12.3)			
17: RtYP analogue output type	depending on the purchase order code: 0-20 or 4-20 mA for current output, 0-10 or 2-10 V for voltage output		0-20 mA (0-10 V)
18: outR analogue output function	OFF , hRnd = manual mode, rEtr = measurement retransmission, cont = control output, detailed description in section 12.3		OFF
19: R-L0 low indication for retransmission	beginning of measurement scale – for the 0/4mA or 0/2V output signals (parameter active only for the measurement retransmission when 18: outR = rEtr)		00 °C
20: R-H high indication for retransmission	End of measurement scale – for the 20mA or 10V output signals (parameter active only for the measurement retransmission when 18: outR = rEtr)		1000 °C
CONFIGURATION OF PID ALGORITHM AND MANUAL MODE			
21: LunA type of PID tuning	OFF , RuLo = automatic selection (continuous tuning), 555P = step method (quick), 555L = oscillation method (slower), section 12.5		OFF
22: Pb PID proportionality range	00 ÷ 1800 or 0 ÷ 9999 units (2), 0 - discontinues PID action; description of PID algorithm and related subjects in sections 12.4 ÷ 12.6		00 °C

23: F PID integration time constant	0 ÷ 9500 sek.	PID algorithm integration time, 0 switches off the PID algorithm's integration module		0 s
24: D PID differentiation time constant	0 ÷ 999 sek.	PID algorithm differentiation time, 0 switches off the PID algorithm's differentiation module		0 s
25: Sc pulsing period	0 ÷ 950 sek.	for binary outputs (1, 2, 3) in manual mode and PID		5 s
26: MSE manual mode set value	0 ÷ 100 % 1% increments	control value for outputs in manual mode, applies for all outputs (1, 2, 3 and analogue), section 12.8		500 %
CONFIGURATION OF PROCESS CONTROLLER (programmable characteristic curve, ramping, section 12.7)				
27: ARR process controller mode (4)	OFF , ARR = manual start, Auto = start after each powering up and adjustment (with the [F] button or BIN input, when 34: Func = 5550)			OFF
28: PR stage 1 gradient	for stage Pr-1 , 0.1 ÷ 99.0 °C/min or 1 ÷ 990 of units/min (2)			0.1 °C
29: th1 stage 2 duration	0 ÷ 8540 min.	duration of stage Pr-2 , 0 stops the Pr-2 stage permanently		90 min.
30: th2 stage 4 duration	0 ÷ 8540 min.	duration of stage Pr-4 , 0 stops the Pr-4 permanently		90 min.
ACCESS AND COMMUNICATION OPTIONS, OTHER CONFIGURATION PARAMETERS				
31: MSE blocked changes in Set1 , Set2	OFF = changes not blocked, Set1 = changes blocked in parameter 9: Set1 , Set2 = changes blocked in 13: Set2 , both = changes blocked simultaneously in 9: Set1 and 13: Set2			OFF
32: PASS access password	0000 ÷ 9999	password to get access to parameter configuration		1111
33: Prn password-protected configuration	OFF	entry to the configuration menu is not password-protected		on
	on	entry to the configuration menu is password-protected		
34: Func [F] button and BIN input function (section 9.1)	none	button [F] and input BIN inactive		none
	Set3	switch over of set value (day/night) for output 1		
	lock	keypad locked (except the [F] button)		
	MAN1	unconditional manual mode for output 1 (P1/SSR1)		
	MAN2	unconditional manual mode for output 2 (P2/SSR2)		
	MAN3	unconditional manual mode for output 3 (P3/SSR3)		
	MANA	unconditional manual mode for analogue output		
5550	control start/stop (applies to all outputs)			
35: br id display brightness	20 ÷ 100 %	display brightness, in 20% increments		100 %
36: Addr MODBUS-RTU address	1 ÷ 247	individual device address in the RS485 network (section 16)		1
37: br baudrate for RS485 and PRG port	24 kbit/s	48 kbit/s	96 kbit/s	192 kbit/s
	384 kbit/s	576 kbit/s	1152 kbit/s	192 kbit/s
38: ARL0 zero calibration	null bias for measurements: -500 ÷ 500 °C or -500 ÷ 500 of units (2)			0.0 °C
39: ARL0 gain	050 ÷ 1150 %	slope calibration (sensitivity) for measurements		1000 %

- Notes:**
- (1) - for **FILT = 1** the response time is 0.25s, for **FILT = 20** at least 3s. Higher level of filtration means a "smoother" measured value and longer response time recommended for turbulent measurements (e.g. water temperature in a boiler)
 - (2) - applies to analogue inputs (mA, V, mV, Ω), when 3: **Loi** is greater than 4: **Hi1**, we get an inverse curve (negative slope)
 - (3) - parameter defines also the output status outside the measuring range
 - (4) - process controller precludes PID auto-tuning and PID control

11. QUICK ACCESS MENU

The measurement mode (measured value display mode) provides an opportunity of an immediate access to some configuration parameters and functions without entering the password. This opportunity is called quick access and is available after pressing the **[SET]** button. The selection and editing of the parameter is analogous to the description in section 10.

Table 11. List of all parameters available in the quick configuration menu

Element	Description
SEt1	set value 1 (parameter 9: SEt1), optional element – unavailable when parameter 8: out1 = hAnd, changes are blocked during the selection of PID (tuning) parameters (section 12.5), in the process controller mode (section 12.7), and change of set value 1 to SEt3 (section 9.1)
SEt2	set value 2 (13: SEt2), optional element – unavailable when parameter 12: out2 = OFF or hAnd
SEt3	set value 3 (16: SEt3), optional element – unavailable when parameter 15: out3 = OFF or hAnd
E-St	PID tuning start/stop (section 12.5), optional element – unavailable when parameter 21: tunE = OFF
P-St	process controller start/stop (section 12.7), optional element – unavailable when parameter 27: rRAP = OFF
MSEt	set value for manual mode (26: MSEt), optional element – available for outputs in manual mode

12. OUTPUTS CONFIGURATION

Programmable architecture of the controller allows it to be used in many fields and applications. Before using the device, its parameters need to be customized (section 10). The detailed description of outputs configuration is given in sections 12.1 ÷ 12.8. The default factory configuration is as follows: outputs 1 and 2 are in the ON-OFF mode with hysteresis, output 3 and analogue outputs are off (Table 10, *Default settings* column).

12.1. CHANGING THE OUTPUTS SET VALUES

In the measurement mode the top display shows the measured value and the bottom one the output 1 set value (parameter 9: SEt1 or 26: MSEt when the controller is in manual mode). The easiest way to change the set value is to use the **[UP]** or **[DOWN]** buttons. Quick access menu (section 11) can be used for other outputs. As an alternative, the modification of each set value is available in the parameter configuration mode, using methods described in section 10.

12.2. TYPES OF OUTPUT CHARACTERISTICS

Type of operation of each output is programmed using the parameters 8: **out1**, 12: **out2**, and 15: **out3**, section 10, Table 10.

a) basic outputs characteristics curves

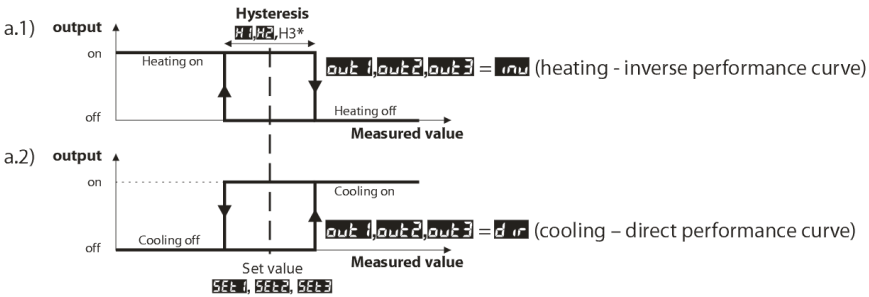

b) additional outputs characteristics curves (only for outputs 2 and 3)

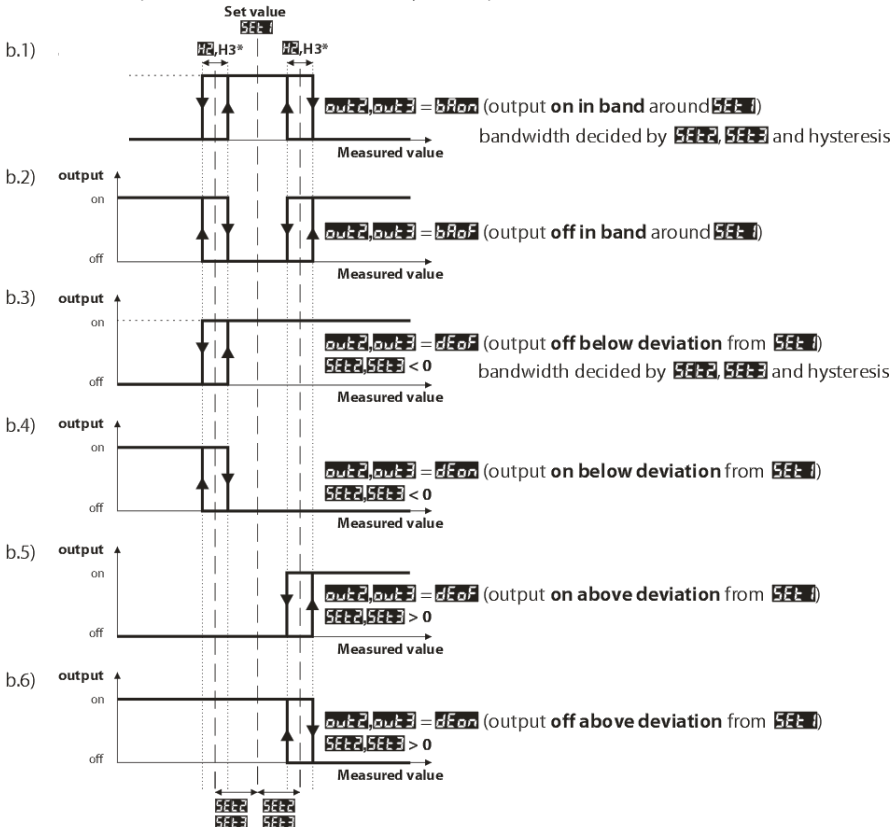

NOTE: * H3 is constant and equals 0.2°C (2 units), not subject to configuration

12.3. ANALOGUE OUTPUT

The output signal standard is determined by parameter 17: $R-LYP$ (section 10, Table 10). The analogue output can be used in one of the following modes: measurement retransmission (parameter 18: $OUTR = rctr$), manual (18: $OUTR = hrrnd$) and as an automatic control output (18: $OUTR = cont$).

In the measurement retransmission mode, the output signal is proportional to the signal measured in the range set by parameters 19: $R-L0$ and 20: $R-H$. (e.g. 0mA for the measured value 0°C when $R-L0 = 0^\circ C$, 20mA for 100°C when $R-H = 100^\circ C$, and correspondingly 10mA for the half range, i.e. 50°C). In other words, in the retransmission mode the output converts the input signal to the output signal (in the $R-L0 \div R-H$ range). Manual mode (section 12.8) allows a smooth conversion of the input signal into the output signal in the 0 ÷ 100% range with 1% increment and initial value equal to the last value in automatic mode (measurement retransmission or control). In the automatic control mode, the parameters and functions are identical as for output 1 (applicable are 7: $FE0$, 8: $OUT1$, 9: $FE1$, 10: $H1$), algorithm and PID tuning parameters and the process control).

In the control mode, the analogue signal variation range is continuous only for the PID algorithm (within the proportionality range, section 12.4), in case of the ON-OFF mode with hysteresis the output has the extreme values (low or high value, e.g. 0mA or 20mA), with no intermediate values.

12.4. PID CONTROL

The PID algorithm gives smaller control errors (e.g. temperature) than the ON-OFF method with hysteresis. However, this algorithm requires the selection of typical parameters for a given controlled facility (e.g. a furnace). To simplify the use, the controller is equipped with advanced functions of selecting the PID parameters which are described in section 12.5. In addition, it is always possible to correct the settings manually (section 12.6).

The controller operates in the PID mode when the proportionality range (parameter 22: Pb) is non-zero. Relation between the proportionality range Pb and the set value $SET1$ is shown in figures 12.4 a) and b). The impact of the integration and differentiation is defined by the parameters 23: t_i and 24: t_d . The parameter 25: t_c determines the pulsing period for output 1 (P1/SSR1). When the PID algorithm is effected by the 0/4÷20mA or 0/2÷10V analogue output, the parameter t_c is irrelevant. In that case, the output signal can have any intermediate value from the entire output variability range.

Regardless of the output type, the output status is always adjusted every 1s.

The principle of operation of the P type (proportional) control for output 1 is shown in figures d), e), for analogue output in figure c).

Fig. 12.4. PID control - principle of operation:

- Relation between the proportionality range Pb and the set value $SET1$ for heating ($OUT1 = inu$)
- Relation between the proportionality range Pb and the set value $SET1$ for cooling ($OUT1 = drr$)
- status of analogue output 0/4÷20 mA or 0/2÷10V
- filling ratio for output 1 (P1/SSR1)
- status of output 1 for measured value within the proportionality range

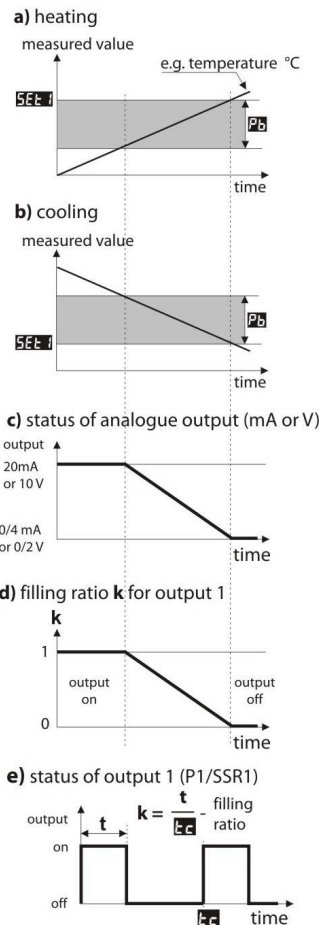

12.5. AUTOMATIC SELECTION OF PID PARAMETERS

The first step to use the function of PID parameters selection is to choose the type of tuning (parameter 21: **tune**, section 10). The tuning will start automatically with start of control (after powering up, and also by pressing the button **[F]**), or by binary input **BIN** when parameter 34: **fund = 515P**, section 9.1). In addition, the tuning can be stopped (**OFF**), and then restarted (**On**) at any time by using the function **t-st** available in the quick access menu (section 11). When the tuning is in progress (i.e. when the display alternately shows the set value and the **tune** message) the set value should not be changed (9: **Set V** or 16: **Set P** when 34: **fund = 515P**).

Value of parameter 21: **tune** determines the method of selecting the PID parameters:

- a) 21: **tune = Auto** - automatic selection – the controller continuously checks if there are conditions to start the tuning and tests the facility to find a suitable method. The algorithm incessantly enforces the PID mode operation. The necessary condition to initiate the PID parameters selection is the measured value being out of the insensitiveness zone which is defined as the sum of parameter 22: **Pb** and 10: **Hh** in relation to set value 9: **Set V**, as in figure 12.5.

Fig.12.5. Insensitiveness zone for heating (8: **out V = mv**) and cooling (8: **out V = dir**)

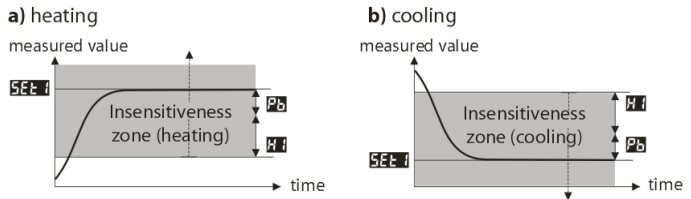

To avoid an unnecessary start of tuning, which may delay the process, it is recommended to set the **Hh** relatively high, at least at 10-30% of the process variability range (e.g. measured temperature variability range). The facility testing with temporary output off and the **tune** message takes place also in the insensitiveness zone if rapid changes of measured or set value are detected.

The method of parameters selection depends on the initial conditions. The fast step method will be used in case of stabilized controlled value, otherwise the slower oscillation method will be applied.

The automatic selection ensures optimum PID parameters for current conditions in the facility, without the user's intervention. It is recommended for variable value control (disturbance of set conditions during operation by modification of e.g. the set value or the furnace batch).

- b) 21: **tune = 515P** – selection of parameters in the step stage (response to step function). While determining the characteristics of the object, the algorithm does not cause an additional delay in reaching the set value. This method is dedicated to facilities with stabilized initial controlled value (e.g. temperature in a cold furnace). In order not to disturb the stabilized initial conditions, before starting the autotuning, turn off the actuator's (e.g. the heater) power supply using an external switch, or use the control start/stop function **[F]** button or **BIN** input). Turn on the power supply again immediately after the autotuning starts, during the output activation delay phase. If the power supply is turned on later, the facility analysis will be incorrect and consequently the PID parameters will not be selected correctly.
- c) 21: **tune = 65ct** – selection of parameters using the oscillation method. The algorithm involves the measurement of the oscillation amplitude and period at a slightly lower level for heating or a slightly higher level for cooling than the set value in order to eliminate the danger that the target value will be exceeded during the facility test stage. While determining the characteristics of the object, the algorithm causes an additional delay in reaching the set value. This method is dedicated to facilities with unstable initial controlled value (e.g. temperature in a hot furnace).

The algorithms from **b** and **c** comprise the following stages:

- output activation delay (about 15s) – time to power up the actuator (heating/cooling power, fan, etc.);
- determination of the facility characteristic curve;
- determination and saving in the controller's non-volatile memory of parameters: 22: **Pb**, 23: **Lt**, 24: **Ld** and 25: **Lc**
- activation of control with new PID settings.

The program can discontinue the autotuning **b** or **c** (with the **Errt** message) if the conditions for correct algorithm operation are not met:

- initial value is higher than the set value for heating or lower for cooling;
- maximum autotuning duration (4 hours) has been exceeded;
- process value changes too quickly or too slowly.

It is recommended to perform the autotuning **b** or **c** after a significant change of the **SEt1** threshold or the controlled facility parameters (e.g. heating/cooling power, charge, initial temperature, etc.).

12.6. ADJUSTMENT OF PID PARAMETERS

The autotuning function correctly selects the PID control parameters for most processes, but sometimes the parameters need adjustment. Due to a strong interdependence of these parameters, adjust only one of them and observe the impact on the process:

- a) oscillation around the threshold – increase the proportionality range 22: **Pb**, increase integration time 23: **ti**, decrease differentiation time 24: **td**, (possibly reduce the output 1 pulsing time by half, parameter 25: **td**);
- b) slow response - reduce the proportionality range **Pb**, differentiation time **td** and integration time **ti**;
- c) overshoot - increase the proportionality range **Pb**, differentiation time **td** and integration time **ti**;
- d) instability – increase the integration time **ti**.

12.7. PROGRAMMABLE CHARACTERISTICS (RAMPING)

Setting of parameter 27: **rRrP** (see section 10, Table 10) to **rRnu** or **Rvto** allows to program the device as a 4-step process controller, implemented by output 1, according to the diagram in presented fig. 12.7. This mode of operation can be started manually at any time (when parameter 27: **rRrP** = **rRnu** or **Rvto**) and automatically (**rRrP** = **Rvto**) when the control process begins (after powering up, and also using the **[F]** button or **BIN** binary input when parameter 34: **Func** = **StSR**, section 9.1). To manually turn the process controller on (**on**) or off (**off**) use the **P-5t** function available in the quick access menu (section 11).

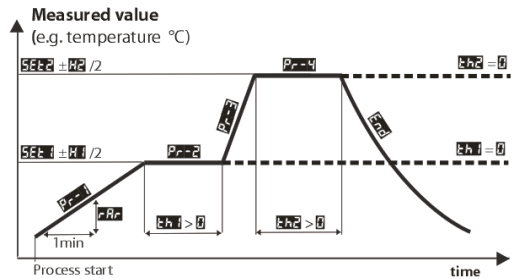

Fig.12.7. 4-step process controller operation diagram

Successive process stages are signalled by the messages displayed alternately with the set value (**SEt1** or **SEt2**):

- **Pr-1** - stage 1 – reaching the value of threshold 9: **SEt1** with the set gradient (28: **rRr**) - ramping
- **Pr-2** - stage 2 – implementation of the 1st hold time 29: **th1** at the **SEt1** level (with hysteresis 10: **Hh1**), the value of parameter **th1** = **0** keeps permanently the stage **Pr-2**
- **Pr-3** - stage 3 – reaching the value of threshold 13: **SEt2** at full power
- **Pr-4** - stage 4 - implementation of the 2nd hold time 30: **th2** at the **SEt2** (with hysteresis 14: **Hh2**) the value of parameter **th2** = **0** keeps permanently the stage **Pr-4**
- **End** - end of process (output 1 permanently off)

In addition, it is possible to assign the output 2 or 3 to the process when parameter 12: **out2** or 15: **out3** equals:

- rEon** - output on after process end (off during the process)
- rEof** - output off after process end (on during the process)
- rEP3** - output on for stages **Pr-3** and **Pr-4**

Operation in the process control mode precludes the PID autotuning and PID adjustment.

12.8. MANUAL AND REMOTE CONTROL OPTION

The manual mode allows to set the output signal over its whole range (0 ÷ 100%), and consequently the enables the open control loop operation (no automatic relationship between the measured value and the output signal). The manual mode is available independently for each controller output and is programmable by the parameters 8: **OUT1**, 12: **OUT2**, 15: **OUT3** and 18: **OUT4** section 10, Table 10. In addition, output can be configured for a quick (unconditional) manual mode controlled by:

- the function button **[F]** or binary input **BIN**, by suitably programming the parameter 34: **Func** (section 9.1),
- sensor measuring errors (exceeding the range or failure), when 7: **Fto1** or 11: **Fto2** is equal to **hAnd**

In case of switching outputs (1, 2, 3), the change of output signal involves setting the filling ratio (using the parameter 26: **HSET**) with pulsing period defined by parameter 25: **LC**. The manual mode set value 26: **HSET** = 0 means that the output is permanently off, value 100 means it is permanently on. This value can be set using the **[UP]** and **[DOWN]** buttons (only for output 1, section 12.1) or the quick access menu (section 11), and alternatively in the parameter configuration mode (from keypad or remotely via the RS485 serial port or PRG, sections 10, 14 ÷ 16).

13. ERRORS AND MESSAGES

a) measuring errors:

Code	Possible errors
----	- below (----) or above (----) the sensor measuring range
----	- sensor damage
----	- other sensor than set in the configuration (section 10, parameter 0: inp)

b) messages and instantaneous errors (single and cyclical):

Code	Message
Code	entering access password to configuration parameters, section 10
Err	wrong access password
Conf	parameter configuration menu
tune	PID autotuning in progress, section 12.5
Errt	autotuning error, section 12.5, to delete error simultaneously press [UP] and [DOWN]
STAR / STOP	control start/stop, section 9.1
SET 1 / SET 3	switch over of set value (day/night) for output 1, section 9.1
blod / boFF	keypad lock on/off, section 9.1
hAnd / hoFF	unconditional manual mode on/off, section 9.1
Pr-1 ÷ Pr-4, End	process control function (ramping), section 12.7
SAVE	save parameter values (section 10)

14. CONNECTING TO THE PC AND AVAILABLE SOFTWARE

Connecting the controller to the PC can be useful (or necessary) in the following situations:

- remote monitoring and recording of current measurement data and process control (outputs status);
- quick configuration of parameters, including copying the settings to other controllers of the same type.

In order to establish a long range communication, set up the connection in the RS485 standard with port available in the computer (directly or by means of the RS485 converter), according to the description in section 15.

In addition, the controllers as a standard are equipped with PRG ports which allow to connect to the PC via the AR955 programming device (without galvanic isolation, cable length 1.2m). To use both the programming device and the RS485 port, the supplied serial port drivers must be installed on the computer.

The communication with the device is based on the protocol compatible with MODBUS-RTU (section 16).

The following applications are available (on CD in the kit with the AR955 programming device, or for downloading from www.apar.pl – Download tag – for Windows 2000/XP/Vista/7/8):

Name	Application
ARSOFT-WZ1 (free)	<ul style="list-style-type: none"> – display current measuring data from connected device – configure the type of measuring input, range of indications, control options, alarms, displaying, communication, access, etc. (section 10) – create a .cfg file on the disc with current parameters configuration to reuse (configuration duplication) – software requires communication with the controller via the RS485 or PRG (AR955)
ARSOFT-WZ4 (free)	<ul style="list-style-type: none"> – create a .cfg configuration file on the disc for later controller programming via the RS485 interface or AR955 and ARSOFT-WZ1 programming device – software does not require communication with the controller
ARSOFT-WZ2 (paid)	<ul style="list-style-type: none"> – display current measuring data from maximum 30 channels simultaneously (only the APAR devices) – software requires communication with the controller via the RS485 or PRG (AR955)

The detailed descriptions of these applications are included in the installation folders.

NOTE: 

Before making the connection, make sure that the controller's MODBUS address (parameter 36: **Addr**) and the baudrate (37: **ba**) are identical to the settings of computer program. In addition, set in the program options the number of the COM serial port (for the RS485 converter or AR955 programming device it is the number given by the operating system during installation of the drivers).

15. RS485 COMMUNICATION INTERFACE (acc. to EIA RS-485)

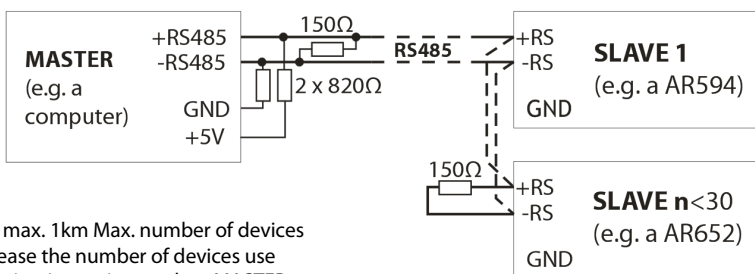

Length of the RS485 cable – max. 1km Max. number of devices in the RS485 line: 30. To increase the number of devices use RS485/RS485 amplifiers. Termination resistors when MASTER is at the beginning of the line (see fig. above):

- at the beginning of the line: 2 x 820Ω to frame and to +5V of the MASTER and 150Ω between lines,
- at the end of the line: 150Ω between lines.

Termination resistors when MASTER is in the middle of the line:

- at the converter: 2 x 820Ω to frame and to +5V of the converter,
- at both ends of the line: 150Ω between lines.

Devices from different manufacturers forming a network 485 (eg converters RS485/USB) may have a built-in termination resistors, and then there is no need for external components.

16. MODBUS–RTU SERIAL TRANSMISSION PROTOCOL (SLAVE)

Format : 8 bits, 1 stop bit, no parity bit

Available function : READ - 3 or 4, WRITE - 6

Table 16.1. Claim frame format for the READ function (frame length – 8 bytes):

device address	function 4 or 3	register address to be read: 0 ÷ 56 (0x0038)	number of registers to be read: 1 ÷ 57 (0x0039)	CRC checksum
1 byte	1 byte	2 bytes (HB-LB)	2 bytes (HB-LB)	2 bytes (LB-HB)

Example 16.1. Read the register with address 0: 0x01 - 0x04 - 0x0000 - 0x0001 - 0x31CA

Table 16.2. Claim frame format for the WRITE function (frame length – 8 bytes):

device address	function 6	register address to be written: 0 ÷ 56 (0x0038)	Value of register to be written	CRC checksum
1 byte	1 byte	2 bytes (HB-LB)	2 bytes (HB-LB)	2 bytes (LB-HB)

Example 16.2. Write the register with address 10 (0xA) value 0: 0x01 - 0x06 - 0x000A - 0x0000 - 0xA9C8

Table 16.3. Reply frame format for the READ function (minimum frame length - 7 bytes):

device address	function 4 or 3	number of bytes in the data field, (max. 57*2=114 bytes)	data field – register value	CRC checksum
1 byte	1 byte	1 byte	2 ÷ 114 bytes (HB-LB)	2 bytes (LB-HB)

Example 16.3. Reply frame for the register value equal to 0: 0x01 - 0x04 - 0x02 - 0x0000 - 0xB930

Table 16.4. Reply frame format for the WRITE function (frame length – 8 bytes):

identical as the claim frame format for the WRITE function (Table 16.2)

Table 16.5. Particular reply (errors: function field = 0x84 or 0x83 for READ function and 0x86 for WRITE function):

Error code (HB-LB in data field)	Error description
0x0001	non-existing register address
0x0002	wrong register value to write
0x0003	incorrect function number

Example 16.5. Error frame for non-existing address to be read: 0x01 - 0x84 - 0x02 - 0x0001 –0x5130

Table 16.6. Map of the MODBUS-RTU protocol registers

Register address HEX (DEC)	Value (HEX or DEC)	Register description and access type (R-read only, R/W-read/write)	
0x00 (0)	-1999 ÷ 19999	current measurement value	R
0x01 (1)	652	device type ID	R
0x02 (2)	100 ÷ 999	controller firmware version	R
0x03 ÷ 0x05	0	not used or reserved	R
0x06 (6)	0 ÷ 7	current outputs status 1, 2, 3: bits 0, 1, 2; bit=1 means output on	R
0x07 (7)	0 ÷ 20000	current status of analogue output (0 ÷ 20000 µA or 0 ÷ 10000 mV)	R

0x08 (8)	-100 ÷ 700	temperature of thermocouples cold ends (resolution 0.1 °C)	R
0x09 ÷ 0x10	0	not used or reserved	R
Configuration parameters (section 10)			
0x11 (17)	0 ÷ 16	parameter 0: INP type of measuring input (section 10)	R/W
0x12 (18)	1 ÷ 20	parameter 1: FILT digital filtration of measurements (response time)	R/W
0x13 (19)	0 ÷ 3	parameter 2: DOT dot position/resolution or resolution for temperature	R/W
0x14 (20)	-1999 ÷ 18000	parameter 3: L1 low limit 1 or bottom of indications range	R/W
0x15 (21)	-1999 ÷ 18000	parameter 4: H1 high limit 1 or top of indications range	R/W
0x16 (22)	-1999 ÷ 18000	parameter 5: L2 low limit 2	R/W
0x17 (23)	-1999 ÷ 18000	parameter 6: H2 high limit 2	R/W
0x18 (24)	0 ÷ 3	parameter 7: EM1 emergency status of output 1	R/W
0x19 (25)	0 ÷ 3	parameter 8: OUT1 function of output 1	R/W
0x1A (26)	-1999 ÷ 18000	parameter 9: SET1 set value 1	R/W
0x1B (27)	0 ÷ 9999	parameter 10: H1 hysteresis of output 1 or PID tuning insensitiveness zone	R/W
0x1C (28)	0 ÷ 3	parameter 11: EM2 emergency status of output 2	R/W
0x1D (29)	0 ÷ 10	parameter 12: OUT2 function of output 2	R/W
0x1E (30)	-1999 ÷ 18000	parameter 13: SET2 set value 2	R/W
0x1F (31)	0 ÷ 9999	parameter 14: H2 hysteresis of output 2	R/W
0x20 (32)	0 ÷ 10	parameter 15: OUT3 function of output 3	R/W
0x21 (33)	-1999 ÷ 18000	parameter 16: SET3 set value 3	R/W
0x22 (34)	0 ÷ 1	parameter 17: RYOP analogue output type	R/W
0x23 (35)	0 ÷ 3	parameter 18: OUTR analogue output function	R/W
0x24 (36)	-1999 ÷ 18000	parameter 19: R-L low indication for retransmission	R/W
0x25 (37)	-1999 ÷ 18000	parameter 20: R-H high indication for retransmission	R/W
0x26 (38)	0 ÷ 3	parameter 21: TUNE type of PID tuning	R/W
0x27 (39)	0 ÷ 18000	parameter 22: PR PID proportionality range	R/W
0x28 (40)	0 ÷ 3600	parameter 23: T PID integration time constant	R/W
0x29 (41)	0 ÷ 999	parameter 24: TD PID differentiation time constant	R/W
0x2A (42)	3 ÷ 360	parameter 25: PC pulsing period	R/W
0x2B (43)	0 ÷ 100	parameter 26: MSV manual mode set value	R/W
0x2C (44)	0 ÷ 2	parameter 27: PRM process controller mode	R/W
0x2D (45)	1 ÷ 300	parameter 28: GR1 stage 1 gradient	R/W
0x2E (46)	0 ÷ 3600	parameter 29: HD1 stage 2 duration	R/W
0x2F (47)	0 ÷ 3600	parameter 30: HD2 stage 4 duration	R/W
0x30 (48)	0 ÷ 3	parameter 31: BSEC blocked changes in SET1 , SET2	R/W
0x31 (49)	0 ÷ 9999	parameter 32: PASS access password	R/W
0x32 (50)	1 ÷ 2	parameter 33: PRP password-protected configuration	R/W
0x33 (51)	0 ÷ 7	parameter 34: FUNC [F] button and BIN input function	R/W
0x34 (52)	20 ÷ 100	parameter 35: BRI display brightness, 20% increments	R/W
0x35 (53)	1 ÷ 247	parameter 36: ADDR MODBUS-RTU address in RS485 network	R/W
0x36 (54)	0 ÷ 6	parameter 37: BA baudrate for RS485 and PRG port	R/W
0x37 (55)	-500 ÷ 500	parameter 38: CBLS null bias for measurements	R/W
0x38 (56)	850 ÷ 1150	parameter 39: CSLO slope calibration (sensitivity) for measurements	R/W

