



PHMM33

Industrial Grade Differential Pressure Transmitter

Pressure

www.eyc-tech.com

eYc PHM33
Industrial Grade Differential Pressure Transmitter

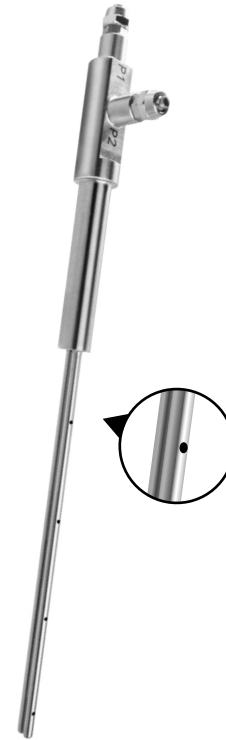

Match with
eYc AFMT Average Flow Measuring Tube
(Pitot tube)

Features

- Option RS-485 communication interface, Modbus RTU protocol
- Physical switch : mbar / Pa / hPa / kPa / mmH₂O / mmWS / inH₂O / mmHg
- Square root function

Introduction

The eYc PHMM33 differential pressure transmitter is designed on the MEMS hot wire anemometer architecture, which has very good zero point stability and small differential pressure detection capability, high pressure resistance. The transmitter uses the pressure difference to pass a very small amount of gas through the air flow channel of the sensor body. Combined with the integrated circuit to convert into a differential pressure signal.

Application

Exhaust emission / Environmental engineering / Air duct / Filter /
Monitor differential pressure and environment air flow

Specification

Input

Input type	Thermo differential pressure module
Measuring range	0 ... 500 pa

Output

Output	0 ... 20 mA / 4 ... 20 mA / 0 ... 1 V 0 ... 5 V / 1 ... 5 V / 2 ... 10 V / 0 ... 10 V
Signal connection	3-wire
ModBus	RS-485
Accuracy(at 25°C)	±0.5% of F.S.
Load resistance(Current output)	4 ... 20 mA < 500 Ω / 0 ... 10 V ≥ 10 KΩ
Response time(t 63)	≤ 2 ms
Display type	LCD Module with back light, double line character
Display range(As unit is Pa)	V=Air velocity(at 25°C) Q=Air quantity(with eYc AFMT)
Height of character	5.56 mm

Environment

Medium	Air
Environment temperature	-20 ... +80°C(Non-display) 0 ... +50°C(Display)
Environment humidity	97%RH(Non-condensing)
Storage temperature	-40 ... +80°C
Compensation	0 ... +70°C

Temperature influence

Temperature drift	±1.75%(-20°C ... 80°C)
-------------------	------------------------

Electrical

Power supply	DC 8 ... 35 V / AC 12 ... 30 V
Current consumption	DC 8 V : ≤120 mA(Display) ≤100 mA(Non-display) DC 24 V : ≤45 mA(Display) ≤40 mA(Non-display) AC 12 V : ≤140 mA(Display) ≤120 mA(Non-display) AC 24 V : ≤90 mA(Display) ≤80 mA(Non-display)
Overvoltage protection	≤DC 40 V
Electrical connection	M12 connector

Installation

Installation	Wall
--------------	------

Protection

IP rating	IP65(Cable) ; IP67(M12)
Electrical protection	■ Polarity protection ■ Over-voltage ■ Short circuit
Pressure resistance	2 bar
Burst pressure	5 bar

Certification

Certification	CE
---------------	----

Material

Housing	Aluminum alloy
Weight	Display : 497 g ; Non-display : 478 g

Pressure unit conversion table

Unit	Pa	mbar	hPa	kPa	mmWS	inH ₂ O	mmHg
Range	50 / 100 / 250	0.5 / 1 / 2.5	0.5 / 1 / 2.5	0.05 / 0.1 / 0.25	5 / 10 / 25	0.2 / 0.4 / 1	0.375 / 0.75 / 1.875
	100 / 300 / 500	1 / 3 / 5	1 / 3 / 5	0.1 / 0.3 / 0.5	10 / 30 / 50	0.4 / 1.2 / 2	0.75 / 2.25 / 3.75

Dimension

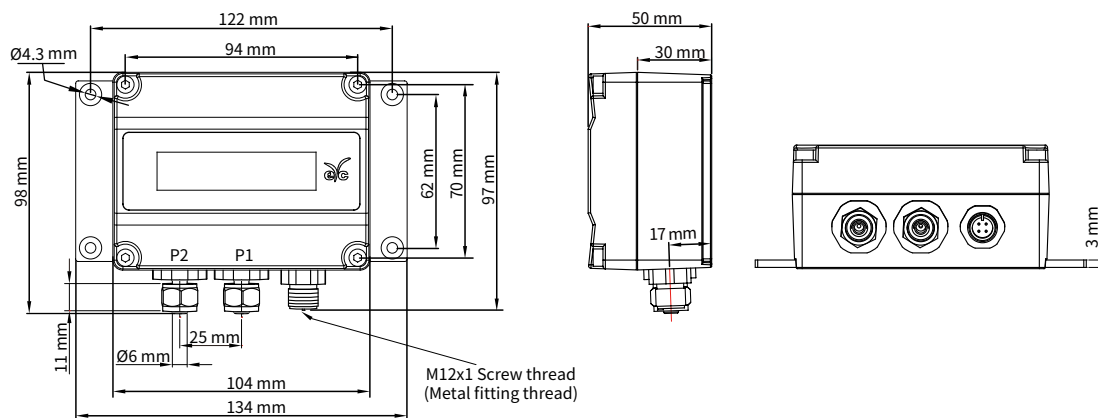

※P1 / P2 : Connected to Ø6 PVC / PTFE compressed air pipe

Diagram

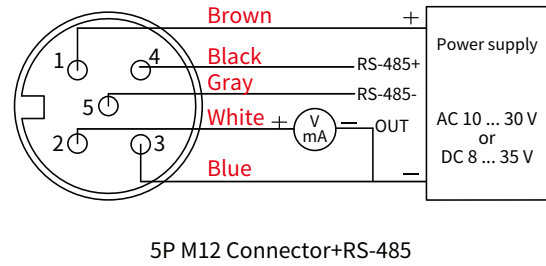
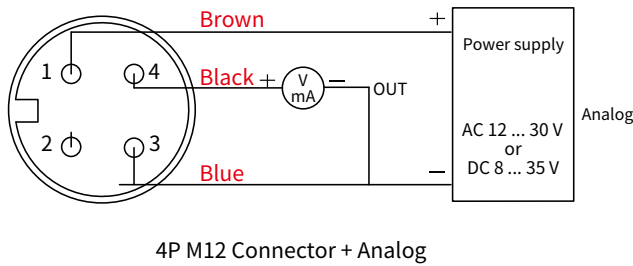

Theory

eYc PHMM33 Industrial Grade Differential Pressure Transmitter is built on the structure of thermal mass flow measurement, with eYc AFMT Average Flow Measuring Tube (Pitot tube), based on the flow continuity formula (the law of conservation of mass) and the Bernoulli formula (the law of conservation of energy), the wind speed calculation formula is deduced to achieve an effective and accurate measurement.

Flow rate formula

$$V = K \sqrt{\frac{2}{\rho} \Delta P}$$

Flow formula

$$q_v = K \varepsilon A \sqrt{\frac{2}{\rho} \Delta P}$$

$$q_m = q_v \times \rho$$

V = Velocity of the liquid (m/s)

ΔP = Difference between total pressure and static pressure
(Dynamic pressure) (Pa)

ρ = Flow density (kg/m³)

K = Flow coefficient

q_v = Volume flow of liquid (m³/s)

q_m = Mass flow of liquid (kg/s)

K = Flow coefficient of average flow measuring

ε = Inflation coefficient of liquid going thru measuring tube during operation

A = Cross-sectional area of duct during operation (m²)

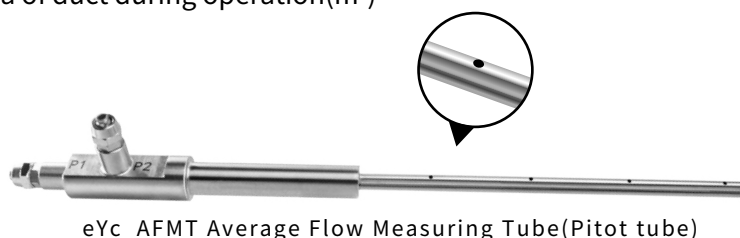
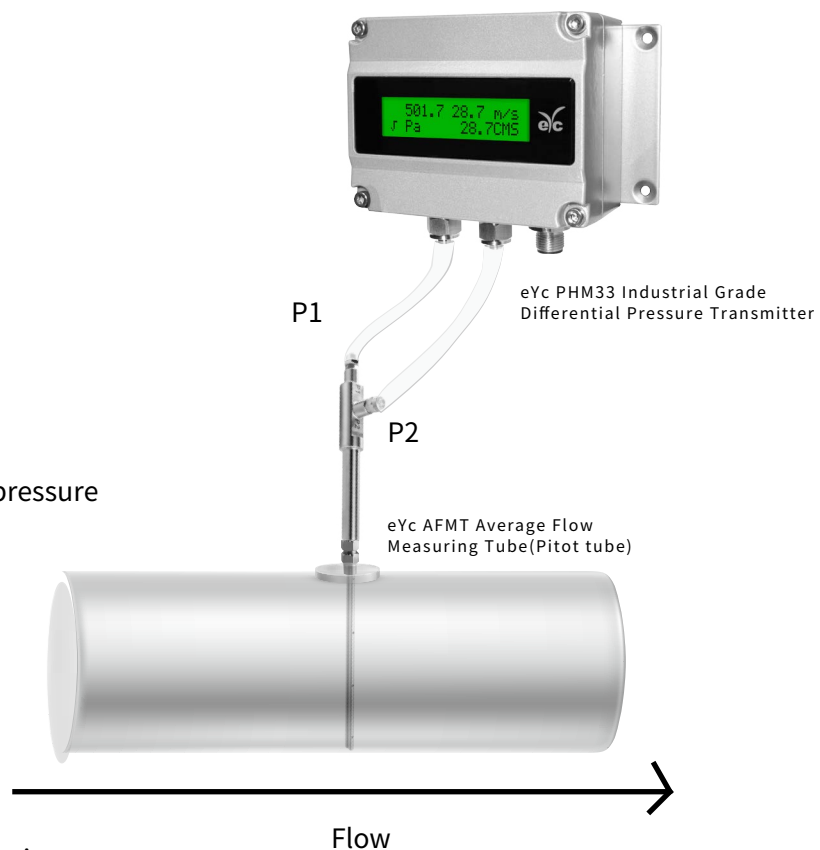

Installation

Varnished wire waste gas treatment product installation drawing

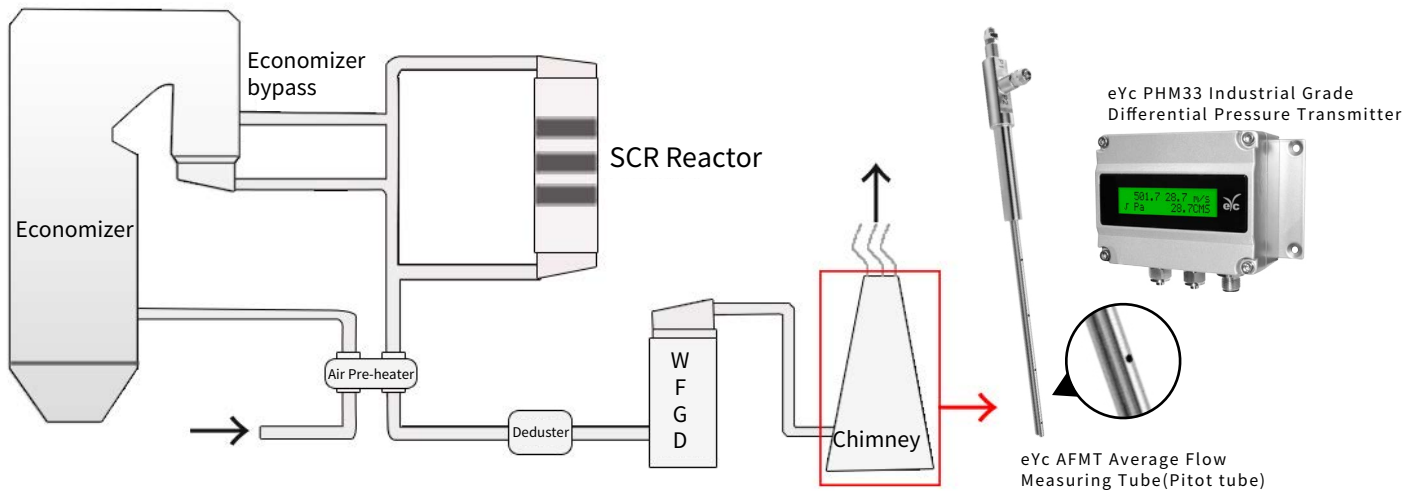

Ordering Guide

Type	PHMM	33	-	20	1	-	M	D
Installation	Wall	33						
Range	50 / 100 / 250 Pa		-	10				
	100 / 300 / 500 Pa		-	20				
Output	4 ... 20 mA				1			
	0 ... 20 mA				2			
	2 ... 10 V				4			
	1 ... 5 V				5			
	0 ... 10 V				6			
	0 ... 5 V				7			
	0 ... 1 V				8			
	Electrical connection	M12x1 metal connector & 2m cable					-	M
Option	Display							D
	RS-485							1

| Additional Option(ILAC / TAF)Test Report |



Additional option : (ILAC / TAF)Test report - Standard calibration laboratory(TAF accreditation : 3032, complying with ISO / IEC 17025)
TAF has mutual recognition arrangement with ILAC MRA

Project	Measurand level or range
Resistance thermometer	-40°C ... +300°C
Thermocouple thermometer	-20°C ... +300°C

Project	Measurand level or range
Hygrometer	3 basic points(25°C / 30%, 50%, 80%)
	Temperature : 0°C ... 70°C
	Humidity : 10% ... 95%