



Overview Probes VA40

Vortex Flow Sensors + Accessories



TÜV qualification tested
for continuous measurement of
exhaust flow rate in the case of
officially approved outgoing air
plants, garbage incinerating
plants and industrial furnaces
according to TA-Luft, 13th and
17th BImSchV.

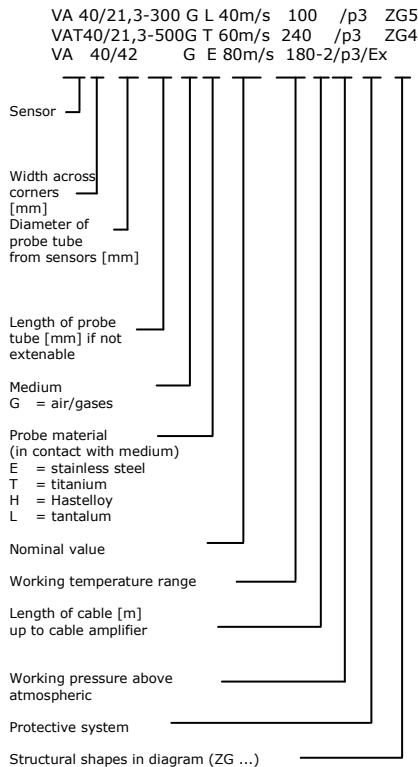

Probes VA as in drawing 5, also available in protective system Ex

	article no.
VA 40/21,3-300 GE 40m/s 100/p3 ZG5	B009/500
VA 40/21,3-300 GH 40m/s 100/p3 ZG5	B009/506
VA 40/21,3-300 GT 40m/s 100/p3 ZG5	B009/510
VA 40/21,3-300 GL 40m/s 100/p3 ZG5*	B009/528
VA 40/21,3-300 GE 40m/s 180/p3 ZG5	B009/514
VA 40/21,3-300 GH 40m/s 180/p3 ZG5	B009/520
VA 40/21,3-300 GT 40m/s 180/p3 ZG5	B009/524
VA 40/21,3-300 GL 40m/s 180/p3 ZG5*	B009/530
VA 40/21,3-300 GE 40m/s 240/p3 ZG5	B009/531
VA 40/21,3-300 GH 40m/s 240/p3 ZG5	B009/532
VA 40/21,3-300 GT 40m/s 240/p3 ZG5	B009/533

* subject to tantalum material price increase

Probes VAT as in drawing 5 with temperature sensor Pt100 under the sensor cap. Output temperature 4-wire Pt100 or 4 ... 20 mA, t/4 ... 20 mA output 2-wire configured.

	article no.
VAT 40/21,3-300 GE 40m/s 100/p3 ZG5	B009/550
VAT 40/21,3-300 GH 40m/s 100/p3 ZG5	B009/556
VAT 40/21,3-300 GT 40m/s 100/p3 ZG5	B009/560
VAT 40/21,3-300 GE 40m/s 180/p3 ZG5	B009/564
VAT 40/21,3-300 GH 40m/s 180/p3 ZG5	B009/570
VAT 40/21,3-300 GT 40m/s 180/p3 ZG5	B009/574
VAT 40/21,3-300 GE 40m/s 240/p3 ZG5	B009/579
VAT 40/21,3-300 GH 40m/s 240/p3 ZG5	B009/580
VAT 40/21,3-300 GT 40m/s 240/p3 ZG5	B009/581

Extendable probes

Probes VA as in drawing 2, also available in protective system Ex

	article no.
VA 40/42 GE 40m/s 100/p3	B009/200
VA 40/42,4 GH 40m/s 100/p3	B009/208
VA 40/42 GT 40m/s 100/p3	B009/212
VA 40/42 GE 40m/s 180-2/p3	B009/216
VA 40/42,2 GH 40m/s 180-2/p3	B009/222
VA 40/42 GT 40m/s 180-2/p3	B009/226
VA 40/42 GE 40m/s 240-2/p3	B009/230
VA 40/42,4 GH 40m/s 240-2/p3	B009/231
VA 40/42 GT 40m/s 240-2/p3	B009/232

Probes VAT as in drawing 2 with temperature sensor Pt100 under the sensor cap. Output temperature 4-wire Pt100

	article no.
VAT 40/42 GE 40m/s 100/p3	B009/250
VAT 40/42,4 GH 40m/s 100/p3	B009/258
VAT 40/42 GT 40m/s 100/p3	B009/262
VAT 40/42 GE 40m/s 180-2/p3	B009/266
VAT 40/42,4 GH 40m/s 180-2/p3	B009/272
VAT 40/42 GT 40m/s 180-2/p3	B009/276
VAT 40/42 GE 40m/s 240-2/p3	B009/280
VAT 40/42,4 GH 40m/s 240-2/p3	B009/281
VAT 40/42 GT 40m/s 240-2/p3	B009/282
Direction indicator RZ42	B099/957
Direction indicator RZ42,4	B099/958

Probes of an exact length

Probes VA as in drawing 4, also available in protective system Ex, Prices without probe guide piece SF (page 4)

	article no.
VA 40/21,3-500 GE 40m/s 100/p3 ZG4	B009/400
VA 40/21,3-500 GH 40m/s 100/p3 ZG4	B009/406
VA 40/21,3-500 GT 40m/s 100/p3 ZG4	B009/410

VA 40/21,3-500 GE 40m/s 180/p3 ZG4	B009/414
VA 40/21,3-500 GH 40m/s 180/p3 ZG4	B009/420
VA 40/21,3-500 GT 40m/s 180/p3 ZG4	B009/424

VA 40/21,3-500 GE 40m/s 240/p3 ZG4	B009/428
VA 40/21,3-500 GH 40m/s 240/p3 ZG4	B009/429
VA 40/21,3-500 GT 40m/s 240/p3 ZG4	B009/430

Probes VAT as in drawing 4 with temperature sensor Pt100 under the sensor cap. Output temperature 4-wire Pt100 or 4 ... 20 mA, t/4 ... 20 mA output 2-wire configured. Prices without probe guide piece SF (page 4)

VAT 40/21,3-500 GE 40m/s 100/p3 ZG4	B009/450
VAT 40/21,3-500 GH 40m/s 100/p3 ZG4	B009/456
VAT 40/21,3-500 GT 40m/s 100/p3 ZG4	B009/460

VAT 40/21,3-500 GE 40m/s 180/p3 ZG4	B009/464
VAT 40/21,3-500 GH 40m/s 180/p3 ZG4	B009/470
VAT 40/21,3-500 GT 40m/s 180/p3 ZG4	B009/474

VAT 40/21,3-500 GE 40m/s 240/p3 ZG4	B009/478
VAT 40/21,3-500 GH 40m/s 240/p3 ZG4	B009/479
VAT 40/21,3-500 GT 40m/s 240/p3 ZG4	B009/480

Additional price for probe tube length Ø 21,3 mm different than above

	article no.
Change of the standard installation length	B099/800
Other installation length 'stainless steel' each 100 mm	B099/800-MM
Other installation length 'titanium' each 100 mm	B099/801-MM
Other installation length 'Hastelloy' each 100 mm	B099/802-MM
Other installation length 'tantalum' each 100 mm	B099/803-MM

Maximum admissible lengths

for probes as in drawing 4
 Measure C 500 ... 1500 mm
 ... 2000 mm at v < 20 m/s

for probes as in drawing 5
 made of stainless steel, Hastelloy or titanium
 Measure A 300 ... 1500 mm

Options

	article no.
Nominal value 60 m/s	V_VA_60
80 m/s	V_VA_80

Probes with a terminal value of 60 m/s may also be used with a U2a transducer up to max. 50 m/s. Probes with a terminal value of 80 m/s require an electronic evaluation unit VSM 80 m/s!

Ex design for flow sensors VA as in drawing ZG4 and 5, but not VAT...
 ATEX category 1/2G (zone 0) Ex ia IIC T6 and category 1/2D (zone 20) Ex ia IIIC TX

VAEX0

Ex design for flow sensors VA as in drawing ZG2, but not VAT...
 ATEX category 2G (zone 1) Ex ia IIC T6

VAEX1

Ex design for flow sensors VA, VAT:
 ATEX category 3G (zone 2) Ex na IIC T6 and 3D (zone 22) Ex tc IIIC TX

VAEX2

Length of cable up to cable amplifier for probes as in drawing 2 longer or shorter than 2 m, max. 10 m/3 m for probes for 180 °C / 240 °C

Basic price probes VA	VAKLV
Basic price probes VAT	VAKLVT
Probe VA each m	VAKLV-M
Probe VAT each m	VAKLVT-M



Probes

Drawing 2

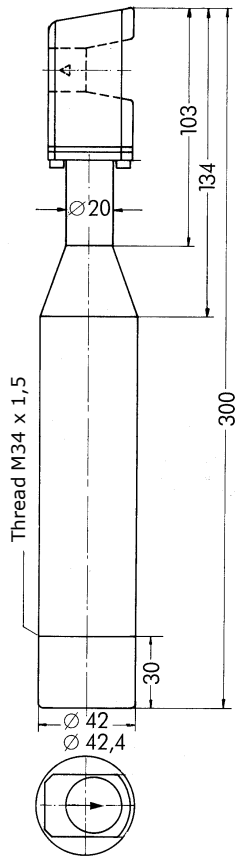

Drawing 4

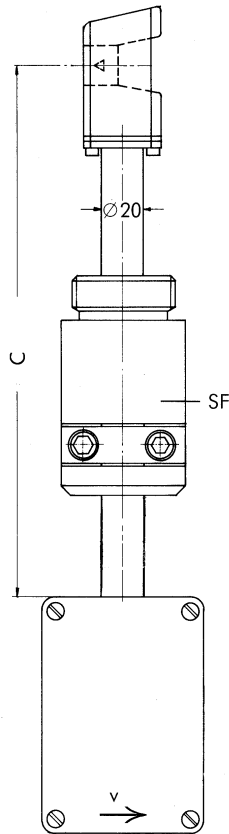

Drawing 5

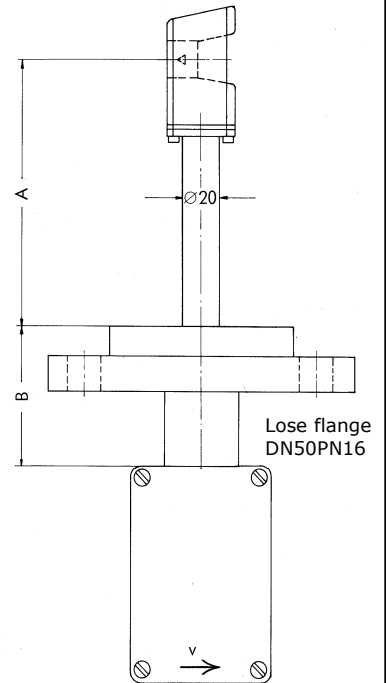

Probe exemplary portrayed with probe guide piece SF (other probe guide pieces can be found on page 4)



Probe guide pieces SF

SFZ = SF with collet chuck
 SFK = SF mit clamp strap
 SFB = SF with clamping bush

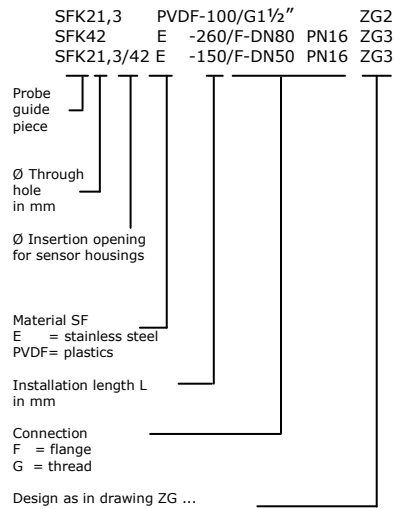

Drawing 1

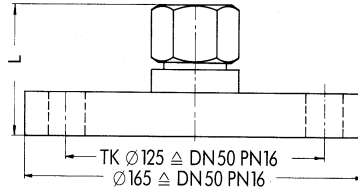

Drawing 2

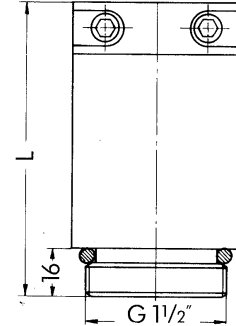

Drawing 3

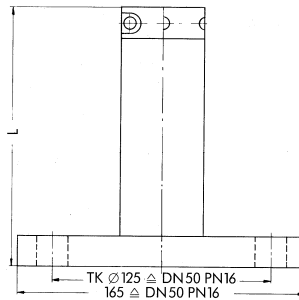

Drawing 5

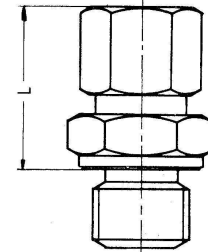

	article no.
SFK 21,3 E- 150/F-DN40 PN16 ZG3 ²⁾	B004/303
SFK 21,3 E- 150/F-DN50 PN16 ZG3 ²⁾	B004/304
SFB 21,3 E-70/F-DN50 PN16 ZG1 ³⁾	B004/103
SFB 21,3 E-53/G1½" ZG5 ^{3) 4)}	B005/504
SFB 21,3 E-80/G2" ZG5 ³⁾	B005/505
SFK 21,3 PVDF ¹⁾ -100/G1½" ZG2 ²⁾	B004/206
SFZ 21,3 PVDF ¹⁾ -125/F-DN50PN16 ZG3 ²⁾	B004/305
SFK 42 E-260/F-DN50 PN16 ZG3 ²⁾	B004/307
SFK 42 E-260/F-DN80 PN16 ZG3 ²⁾	B004/308
SFZ 42 PVDF ¹⁾ -225/F-DN50 PN16 ZG3 ²⁾	B004/309
SFK 42,4 E-260/F-DN50 PN16 ZG3 ²⁾	B004/310
SFK 42,4 E-260/F-DN80 PN16 ZG3 ²⁾	B004/311
SFZ 42,4 PVDF ¹⁾ -225/F-DN50PN16 ZG3 ²⁾	B004/312
SFK 21,3/42 E-150/F-DN50 PN16 ZG3 ²⁾ with flanged ball valve DN50PN16 ball valve approx. 150 mm long	B004/313
SFK 21,3/42 E-150/F-DN50 PN16 ZG3 ²⁾ (without flange ball valve DN50PN16)	B004/314

1) for max +120 °C

Seal material:

- VITON® lip seal
 - TEFLON® clamping bush
 - VITON®
- ® DuPont trademark

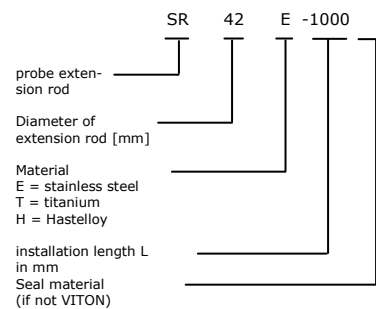

Probe extensions for probes as in drawing 2	article no.
SR42E-350	B099/510
SR42E-500	B099/511
SR42E-1000	B099/512
SR42,4H-500	B099/513
SR42,4H-1000	B099/514
SR42T-500	B099/515

Höntzsch GmbH

P.O. Box 1324 D-71303 Waiblingen
 Gottlieb-Daimler-Straße 37
 D-71334 Waiblingen (Hegnach)
 Telephone 07151/1716-0
 Facsimile 07151/58402
 E-Mail info@hoentzsch.com

จัดจำหน่ายโดย

บริษัท โอเมก้า เมชเชอริง อินสตรูเมนต์ จำกัด
 50/23 หมู่ 3 ต.มหาสวัสดิ์ อ.บางกรวย จ.นนทบุรี 11130
 Tel : 02 105 4676
 Fax : 02 903 0080 ext. 6867
 Email : info@omi.co.th